

**ORTHOPEDIC  
INSTRUMENTS  
CATALOGUE**

## Mallets Weight Refer To The Heads Of The Mallets



∅ 20 mm

½

**06-8271**  
MEAD  
185 g  
with interchangeable  
plastic disks  
190 mm  
**06-8272**  
pair of spare disks



∅ 25 mm

½

**06-8273**  
140 g  
with interchangeable  
plastic disks  
185 mm  
**06-8274**  
pair of spare disks



∅ 30 mm

½

**06-8275**  
COTTLE  
240 g  
1 Side flat  
1 Side convex  
185 mm



∅ 22 mm

½

**06-8276**  
165 g  
lead filled head  
190 mm



# Mallets, Weights Refer To The Heads



**06-8277**  
HAJEK  
140 g  
220 mm



**06-8278**  
215 g  
with interchangeable  
plastic disks  
245 mm  
**06-8279**  
pair of spare disks

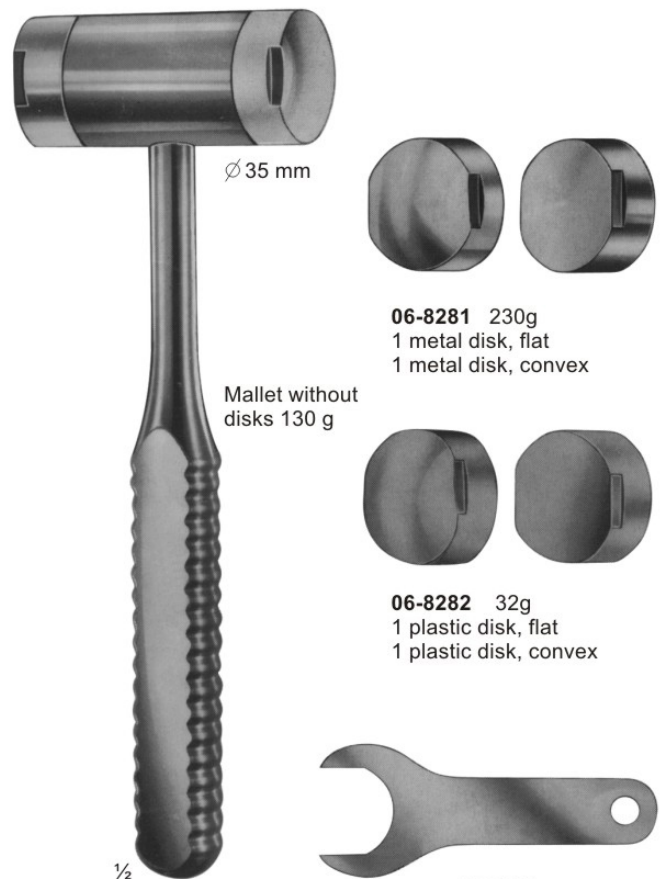

**06-8280 - 06-8283**  
WAGNER  
complete with:  
1 pair of metal disks (**06-8281**) and  
1 pair of plastic disks(**06-8282**) and  
1 wrench (**06-8283**)  
235 mm

**06-8281** 230g  
1 metal disk, flat  
1 metal disk, convex

Mallet without  
disks 130 g

**06-8282** 32g  
1 plastic disk, flat  
1 plastic disk, convex

**06-8283**  
Wrench

# Mallets Weight Refer To The Heads Of The Mallets



**06-8284** 300g  
BERGMANN  
245 mm



**06-8285** 300g  
BERGMANN  
235 mm



**06-8286** 550g  
OMBREDANNE  
240 mm



**06-8287**  
HEATH  
copper filled head  
700 g  
185 mm



# Tampers - Osteotomes, Chisels and Gouge

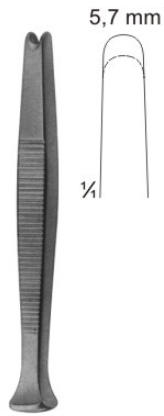

**06-8288**  
HAASE  
100 mm



**06-8289 - 06-8290**  
PASSOW  
120 mm



**06-8291 - 06-8293**  
CASPAR  
200 mm

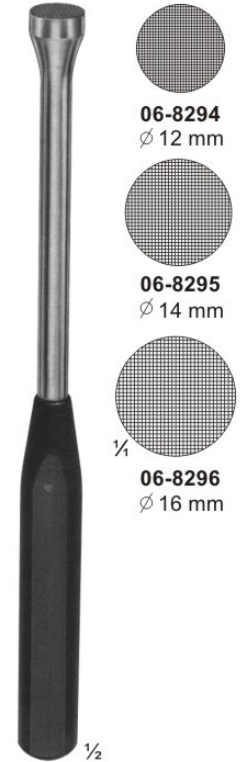

**06-8294 - 06-8296**  
200 mm

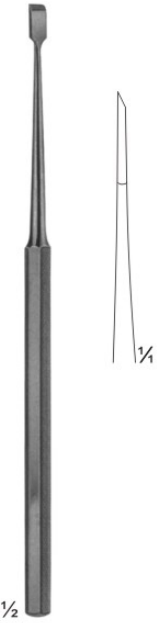

**06-8297** 4mm  
FREER  
Chisel  
160 mm

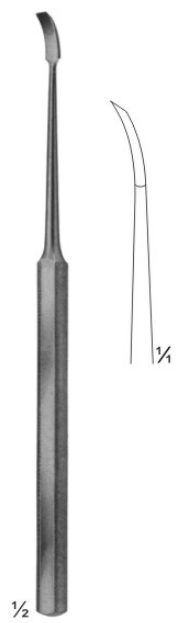

**06-8298** 4mm  
FREER  
Chisel, curved  
160 mm

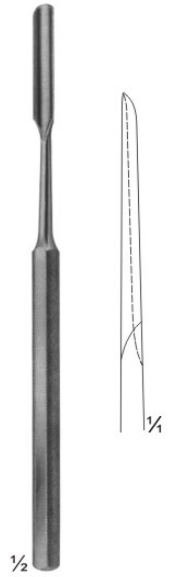

**06-8299** 6mm  
FREER  
Gouge  
150 mm

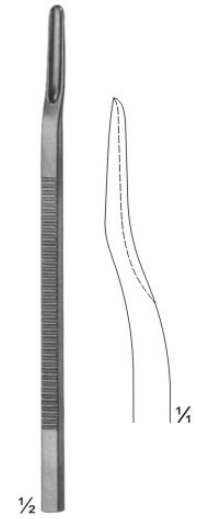

**06-8300** 3.4mm  
Scaphoid gouge,  
downwards curved  
135 mm

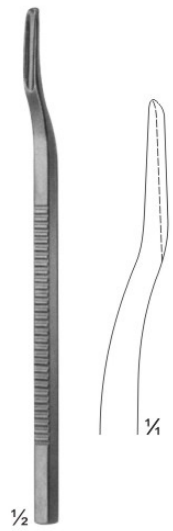

**06-8301** 3.4mm  
Scaphoid gouge,  
upwards curved  
135 mm



**06-8302 - 06-8304**  
MANNERFELT modif  
Osteotomes  
**06-8302** 4 mm  
**06-8303** 6 mm  
**06-8304** 8 mm  
155 mm

# Osteotomes Chisels and Gouges

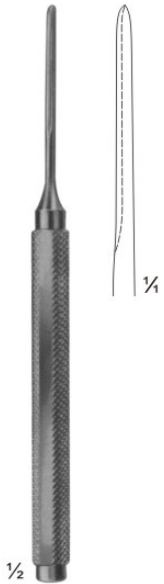

**06-8305** 3mm  
MANNERFELT modif.  
Gouge  
155 mm

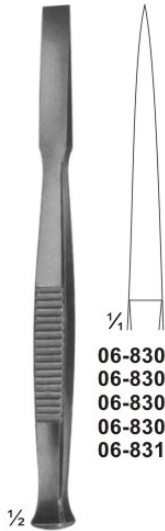

**06-8306 - 06-8310**  
Osteotomes  
140 mm

- 06-8306** 4 mm
- 06-8307** 6 mm
- 06-8308** 8 mm
- 06-8309** 10 mm
- 06-8310** 12 mm

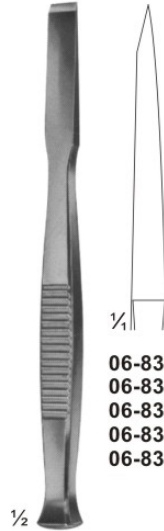

**06-8311 - 06-8315**  
Chisels  
140 mm

- 06-8311** 4 mm
- 06-8312** 6 mm
- 06-8313** 8 mm
- 06-8314** 10 mm
- 06-8315** 12 mm

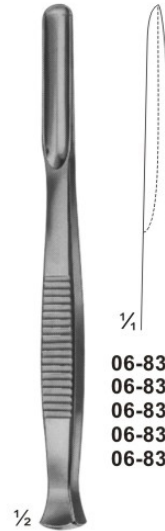

**06-8316 - 06-8320**  
Gouges  
140 mm

- 06-8316** 4 mm
- 06-8317** 6 mm
- 06-8318** 8 mm
- 06-8319** 10 mm
- 06-8320** 12 mm

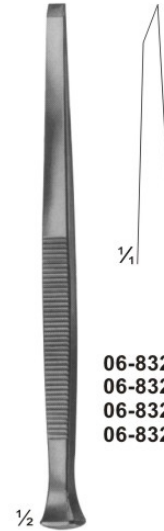

**PARTSCH**  
**06-8321 - 06-8324**  
Chisels  
140 mm

- 06-8321** 3 mm
- 06-8322** 4 mm
- 06-8323** 5 mm
- 06-8324** 6 mm

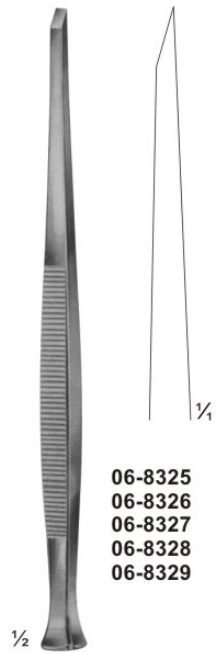

**PARTSCH**  
**06-8325 - 06-8329**  
Chisels  
170 mm

- 06-8325** 3 mm
- 06-8326** 4 mm
- 06-8327** 5 mm
- 06-8328** 6 mm
- 06-8329** 7 mm

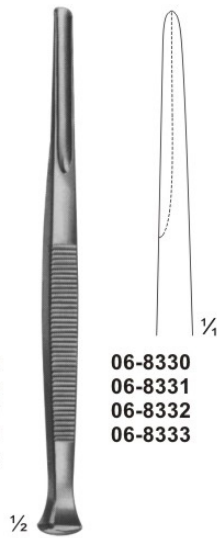

**PARTSCH**  
**06-8330 - 06-8333**  
Gouges  
140 mm

- 06-8330** 3 mm
- 06-8331** 4 mm
- 06-8332** 5 mm
- 06-8333** 6 mm

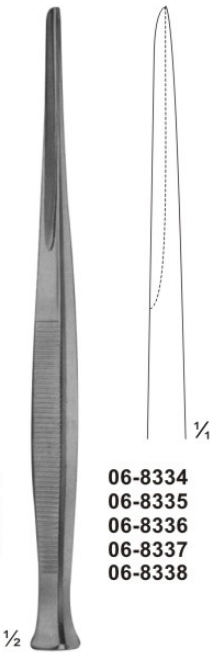

**PARTSCH**  
**06-8334 - 06-8338**  
Gouges  
170 mm

- 06-8334** 3 mm
- 06-8335** 4 mm
- 06-8336** 5 mm
- 06-8337** 6 mm
- 06-8338** 7 mm

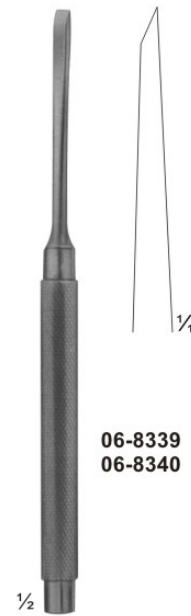

**LUCAS**  
**06-8339 - 06-8340**  
Chisels  
160 mm

- 06-8339** 4 mm
- 06-8340** 6 mm

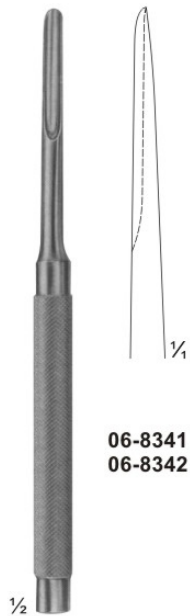

**LUCAS**  
**06-8341 - 06-8342**  
Gouges  
160 mm

- 06-8341** 3 mm
- 06-8342** 5 mm



# Osteotomes Chisels and Gouges

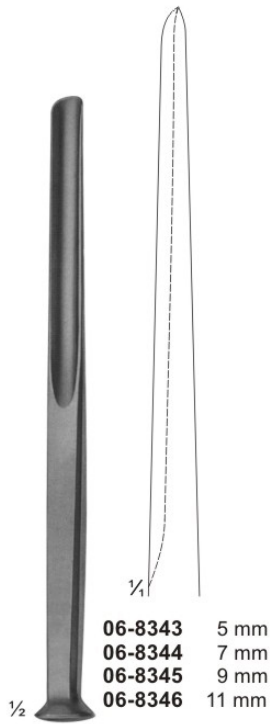

- 06-8343 5 mm
- 06-8344 7 mm
- 06-8345 9 mm
- 06-8346 11 mm

**ALEXANDER**  
06-8343 - 06-8346  
Gouges  
170 mm

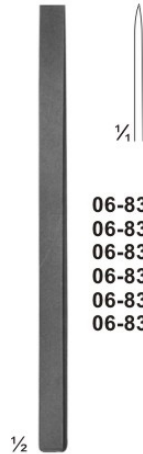

- 06-8347 4 mm
- 06-8348 6 mm
- 06-8349 8 mm
- 06-8350 10 mm
- 06-8351 12 mm
- 06-8352 15 mm

**LAMBOTTE**  
06-8347 - 06-8352  
Osteotomes  
125 mm

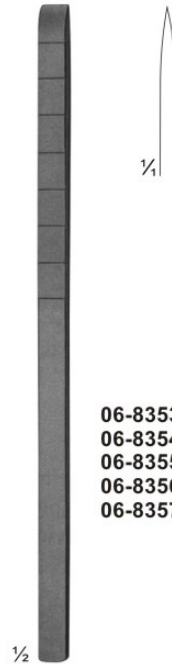

- 06-8353 4 mm
- 06-8354 6 mm
- 06-8355 8 mm
- 06-8356 10 mm
- 06-8357 12 mm

**COTTLE**  
06-8353 - 06-8357  
Osteotomes with depth  
markings  
180 mm

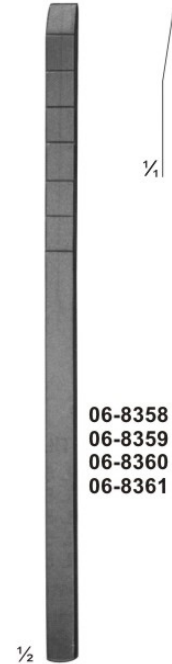

- 06-8358 4 mm
- 06-8359 7 mm
- 06-8360 9 mm
- 06-8361 12 mm

**COTTLE**  
06-8358 - 06-8361  
Chisel-Osteotomes  
with depth markings  
180 mm

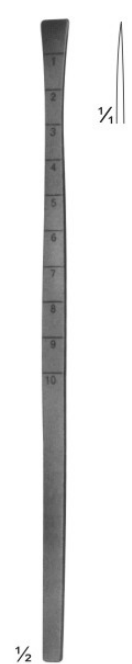

**COTTLE**  
06-8362 8mm  
Fish-tail Chisel,  
with protected ends  
180 mm

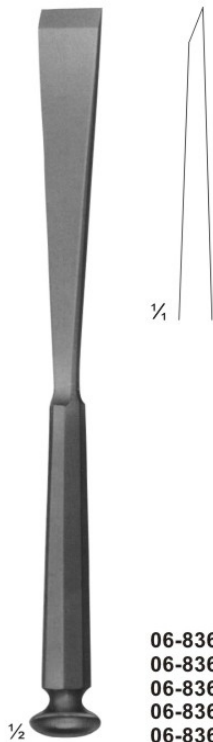

- 06-8363 10 mm
- 06-8364 12 mm
- 06-8365 15 mm
- 06-8366 20 mm
- 06-8367 25 mm

**STILLE**  
06-8363 - 06-8367  
Chisels  
205 mm

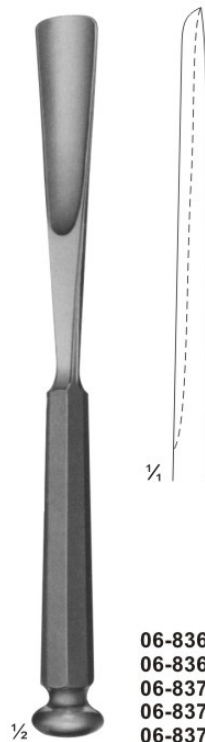

- 06-8368 10 mm
- 06-8369 12 mm
- 06-8370 15 mm
- 06-8371 20 mm
- 06-8372 25 mm

**STILLE**  
06-8368 - 06-8372  
Gouges  
205 mm

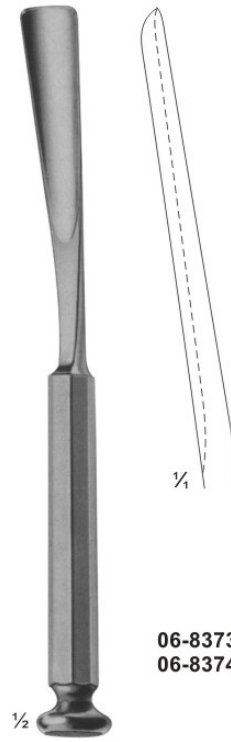

- 06-8373 10 mm
- 06-8374 15 mm

**WALTER**  
06-8373 - 06-8374  
gouges for taking  
grafts from the ribs  
205 mm



- 06-8375 8 mm
- 06-8376 10 mm
- 06-8377 12 mm
- 06-8378 15 mm
- 06-8379 20 mm
- 06-8380 25 mm

**STILLE**  
06-8375 - 06-8380  
Osteotomes  
205 mm

# Osteotomes



**STILLE**  
**06-8381 - 06-8385**  
 Osteotomes  
 205 mm

**STILLE**  
**06-8386 - 06-8390**  
 Osteotomes, curved  
 205 mm

**LAMBOTTE**  
**06-8391 - 06-8402**  
 Osteotomes  
 245 mm

**LAMBOTTE**  
**06-8403 - 06-8408**  
 Osteotomes, curved  
 245 mm



# Osteotomes, Chisels and Gouges with HARTPRESS -handle

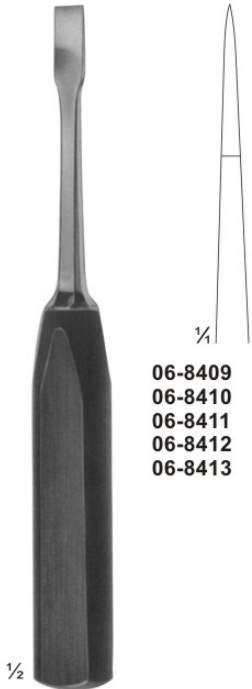

- 06-8409 4 mm
- 06-8410 6 mm
- 06-8411 8 mm
- 06-8412 10 mm
- 06-8413 12 mm

LEXER-MINI  
06-8409 - 06-8413  
Osteotomes  
180 mm



- 06-8414 4 mm
- 06-8415 6 mm
- 06-8416 8 mm
- 06-8417 10 mm
- 06-8418 12 mm

LEXER-MINI  
06-8414 - 06-8418  
Gouges  
180 mm

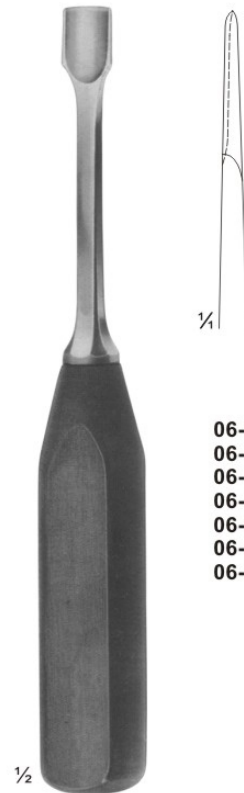

- 06-8419 5 mm
- 06-8420 7 mm
- 06-8421 10 mm
- 06-8422 15 mm
- 06-8423 20 mm
- 06-8424 25 mm
- 06-8425 30 mm

LEXER  
06-8419 - 06-8425  
Gouges  
220 mm



- 06-8426 5 mm
- 06-8427 7 mm
- 06-8428 10 mm
- 06-8429 15 mm
- 06-8430 20 mm
- 06-8431 25 mm
- 06-8432 30 mm

LEXER  
06-8426 - 06-8432  
Osteotomes  
220 mm



06-8433 9mm  
Gouge for  
removing broken  
screws  
220 mm



- 06-8434 5,5 mm
- 06-8435 9,0 mm

ZIELKE  
06-8434 - 06-8435  
Gouges for  
scoliosis-operations  
230 mm

# Osteotomes ,Chisels and Gouges with HARTPRESS -handle





# Reposition Forceps, Bone Holding Forceps



**06-8447**  
Patella forceps  
185 mm



**06-8448**  
Forceps with  
ratchet fixation  
140 mm



**06-8449**  
Forceps with  
thread fixation  
170 mm



**06-8450**  
Forceps with  
thread fixation  
235 mm

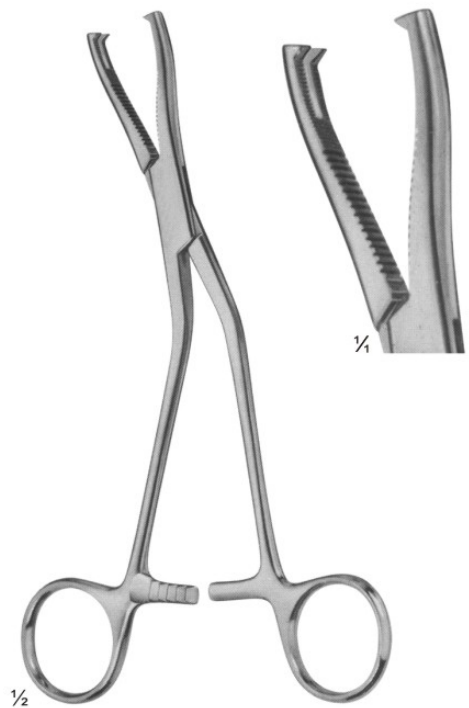

**06-8451**  
DINGMANN modif  
185 mm

# Bone Holding Forceps



**06-8452**  
Sequestrum  
forceps  
200 mm



**06-8453**  
VAN BUREN  
Sequestrum  
forceps  
225 mm



**06-8454**  
LANGENBECK  
205 mm



**06-8455**  
FERGUSON  
205 mm

# Bone Holding Forceps

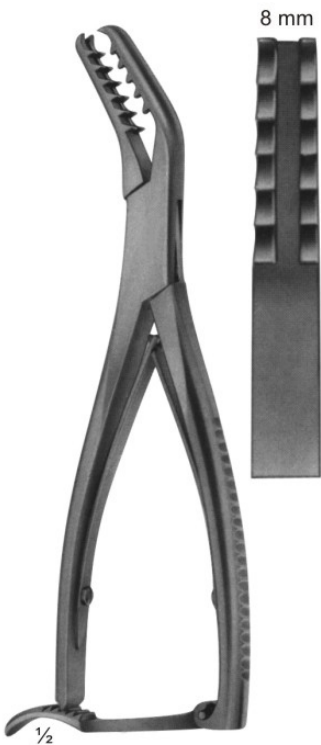
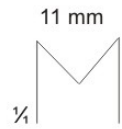
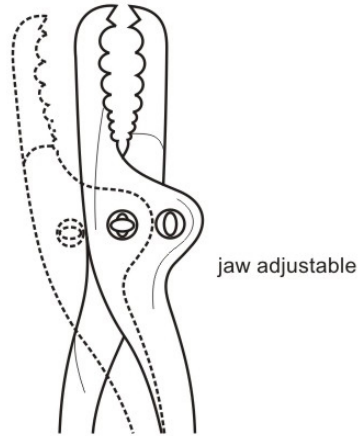

**06-8456**  
SEMB  
190 mm



**06-8457**  
FARABEUF  
230 mm



**06-8458**  
FARABEUF  
255 mm



**06-8459**  
FARABEUF-LAMBOTTE  
255 mm



## Bone Holding Forceps

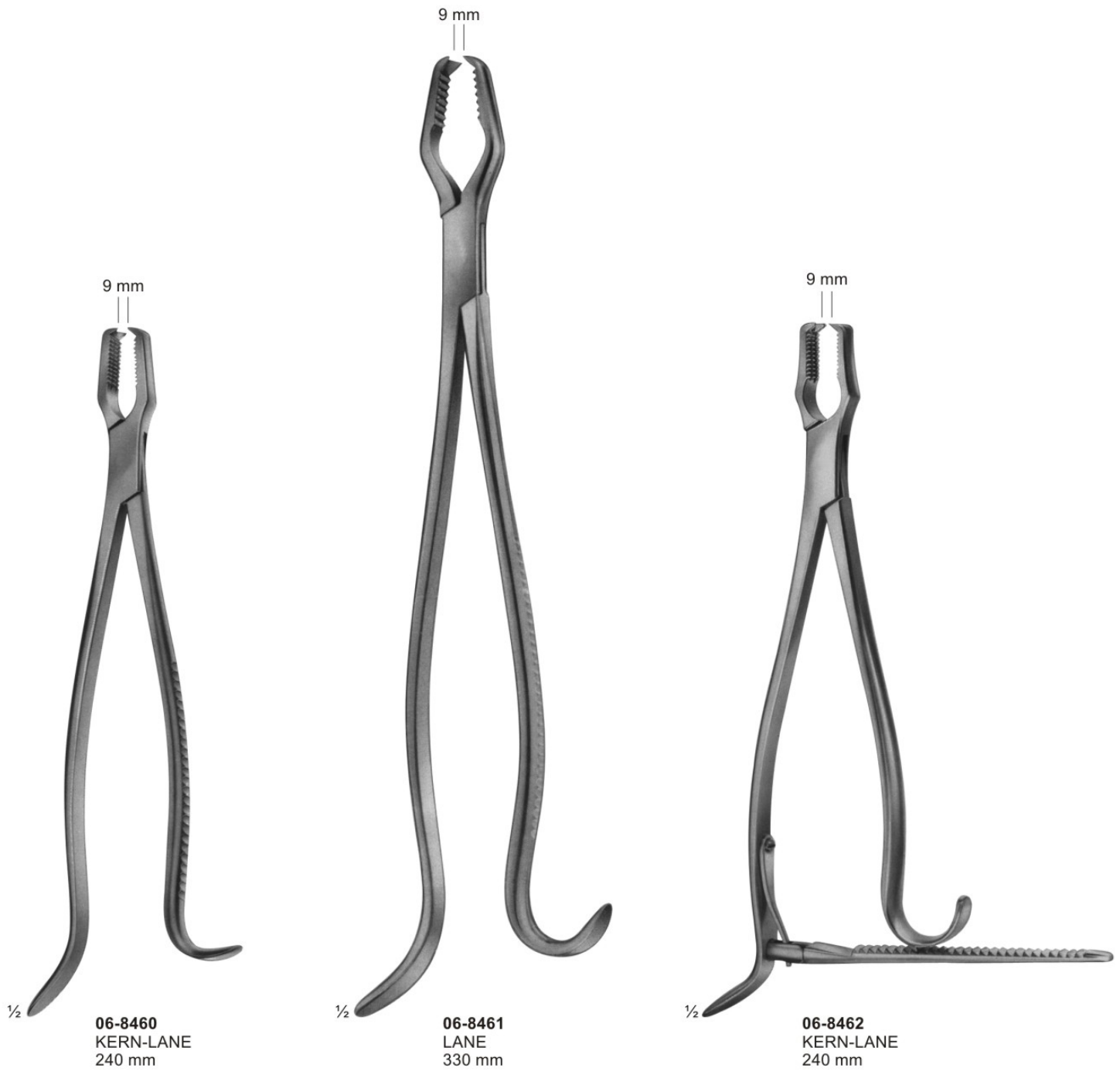

## Bone Holding Forceps



# Bone Holding Forceps

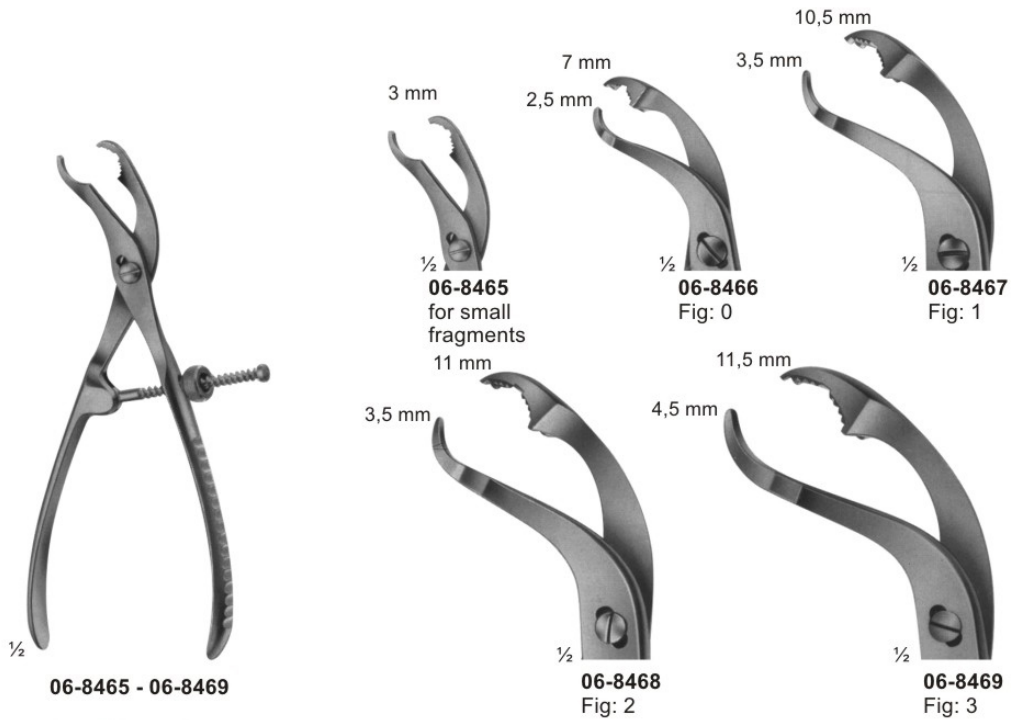

- 06-8465** 145 mm
- 06-8466** 190 mm
- 06-8467** 240 mm
- 06-8468** 260 mm
- 06-8469** 280 mm

Self-centering forceps  
with thread fixation

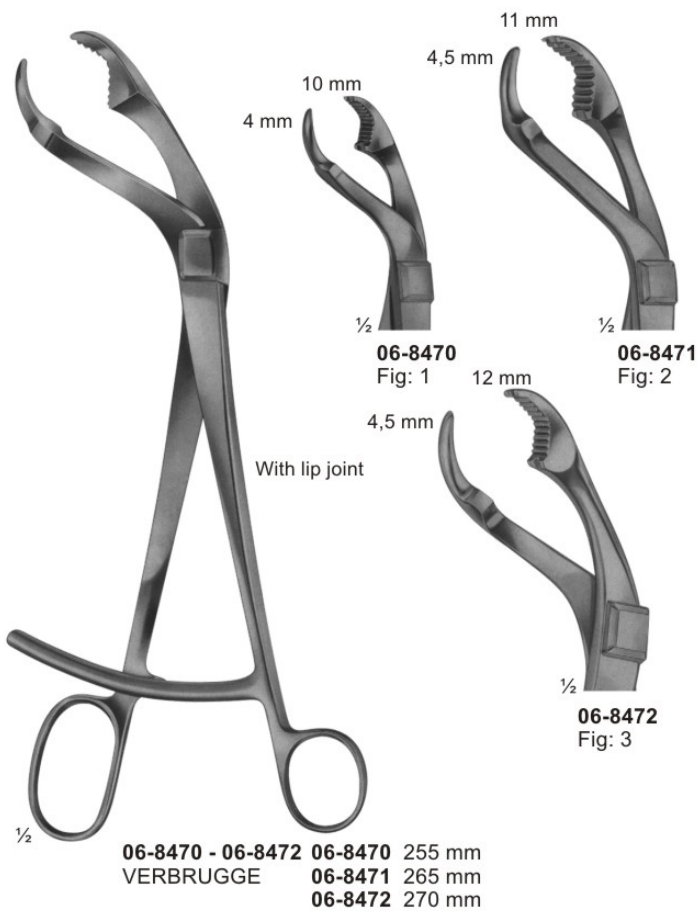

- 06-8470 - 06-8472** **06-8470** 255 mm
- VERBRUGGE** **06-8471** 265 mm
- 06-8472** 270 mm



- 06-8473**
- LAMBOTTE**
- 265 mm



# Bone Rongeurs



**06-8487**  
LUER  
150 mm

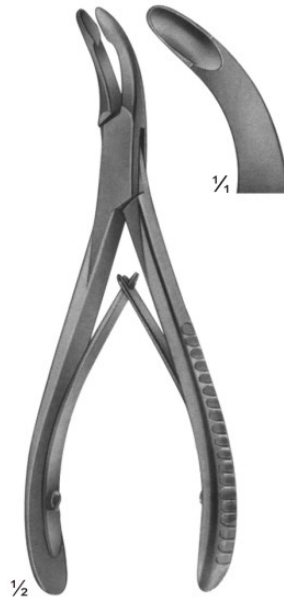

**06-8488**  
LUER  
155 mm

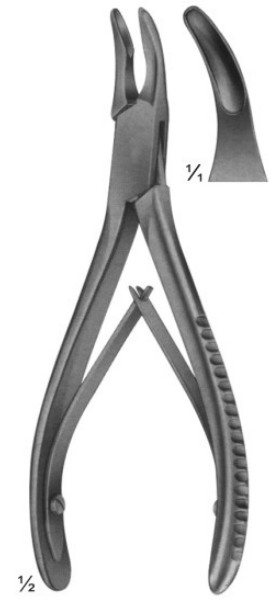

**06-8489**  
BLUMENTHAL  
155 mm

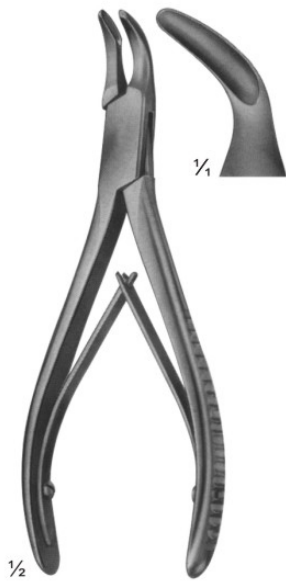

**06-8490**  
BLUMENTHAL  
150 mm



**06-8491 - 06-8492**  
JANSEN  
175 mm

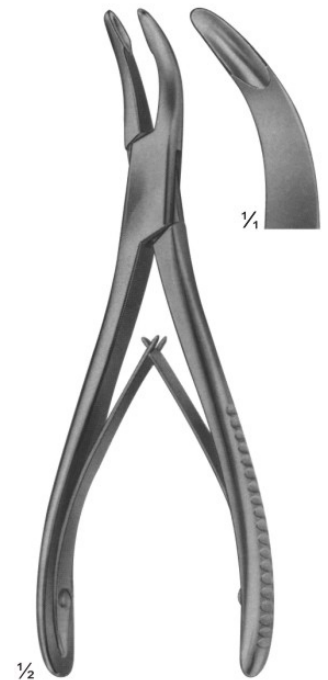

**06-8493**  
BANE-HARTMANN  
175 mm

# Bone Rongeurs

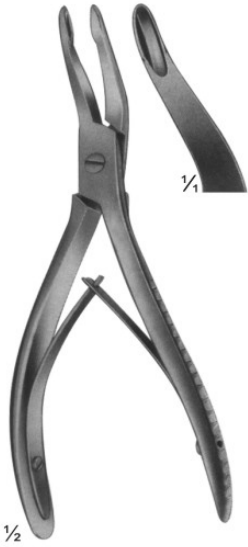

**06-8494**  
ALEXANDER  
140 mm

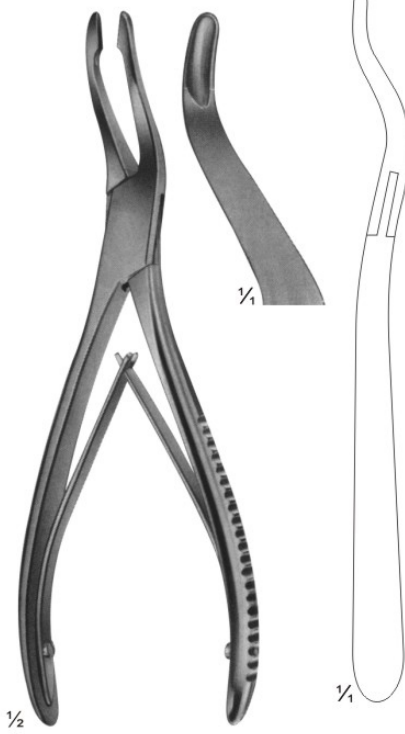

**06-8495**  
JANSEN  
190 mm



**06-8496 - 06-8497**  
LEMPERT  
200 mm

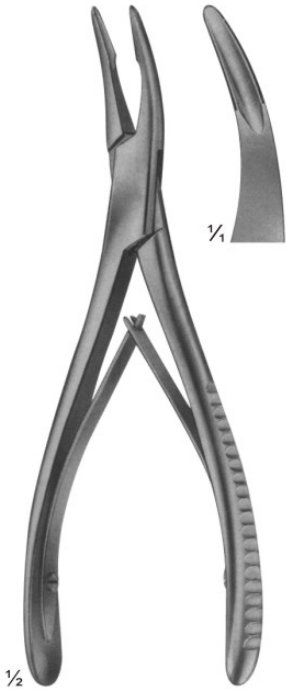

**06-8498**  
BEYER  
180 mm

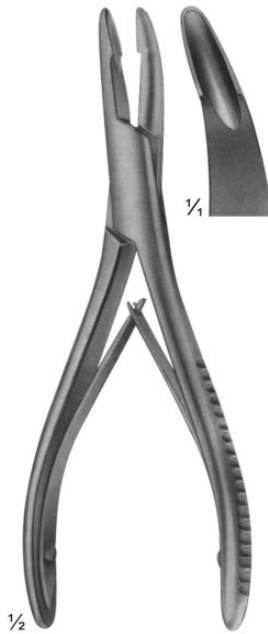

**06-8499**  
MEAD  
165 mm

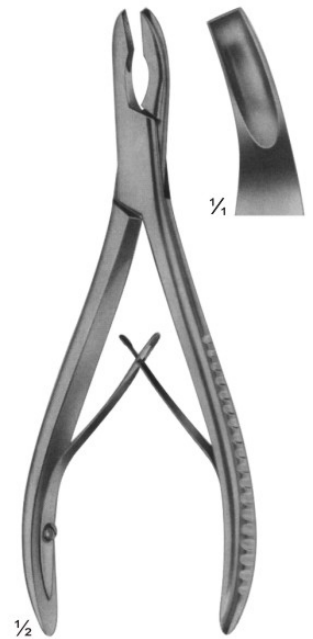

**06-8500**  
MEAD  
165 mm

# Bone Rongeurs

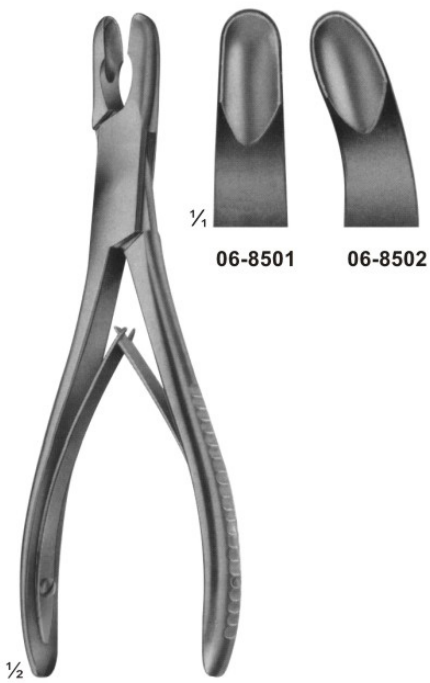

**06-8501 06-8502**

**06-8501 - 06-8502**  
LUER  
175 mm

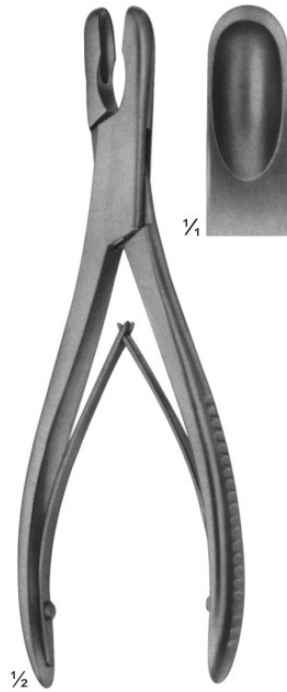

**06-8503**  
LUER  
180 mm

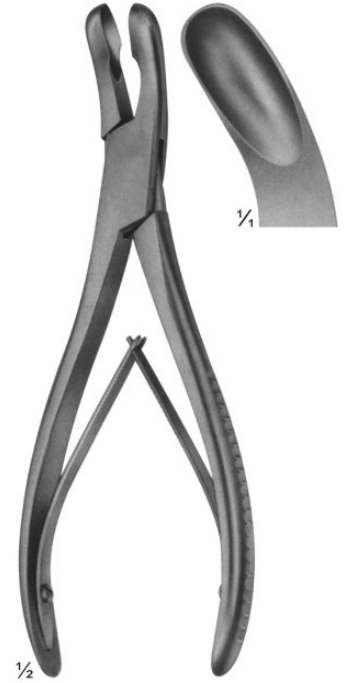

**06-8504**  
LUER  
180 mm

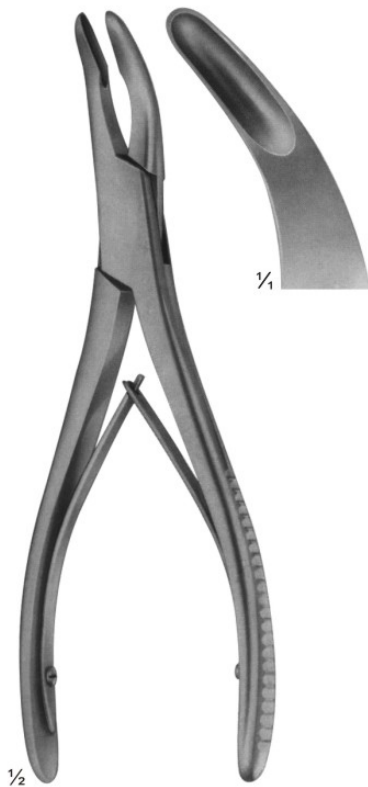

**06-8505**  
OLIVECRONA  
205 mm



**06-8506 - 06-8507**  
BOHLER  
155 mm



**06-8508**  
MARQUARDT  
200 mm



# Bone Rongeurs



**06-8509**  
RUSKIN  
190 mm



**06-8510**  
ROETTGEN-RUSKIN  
240 mm



**06-8511 - 06-8512**  
ECHLIN  
230 mm

# Bone Rongeurs



**06-8513**  
STILLE  
235 mm



**06-8514**  
LEKSELL-STILLE  
240mm



**06-8515**  
STILLE-RUSKIN  
240mm

# Bone Rongeurs

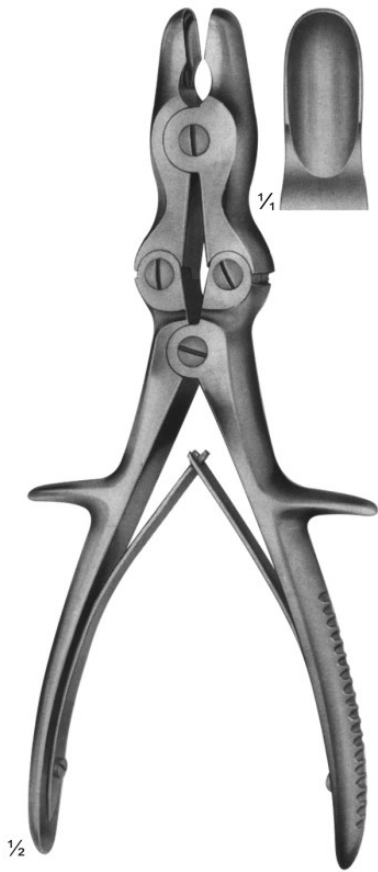

**06-8516**  
LUER-STILLE  
225 mm



**06-8517**  
LUER-STILLE  
225 mm



# Bone Rongeurs



**06-8518**  
LUER-STILLE  
270 mm

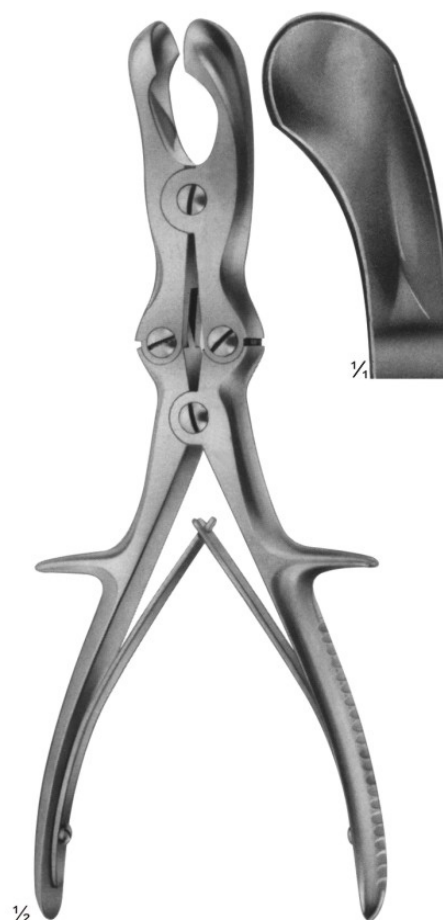

**06-8519**  
SEMB  
240 mm

# Bone Cutting Forceps

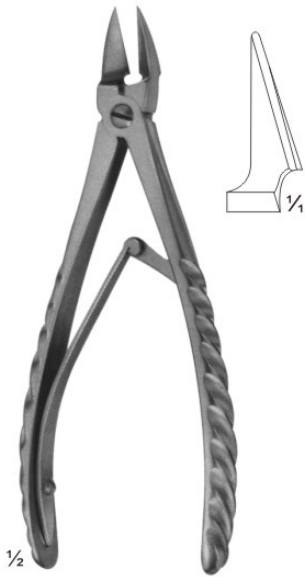

**06-8520**  
STAMM  
150 mm



**06-8521**  
KAZANJIAN  
185 mm



**06-8522 - 06-8525**  
LISTON



**06-8522**  
140 mm



**06-8523**  
170 mm



**06-8524**  
200 mm



**06-8525**  
220 mm

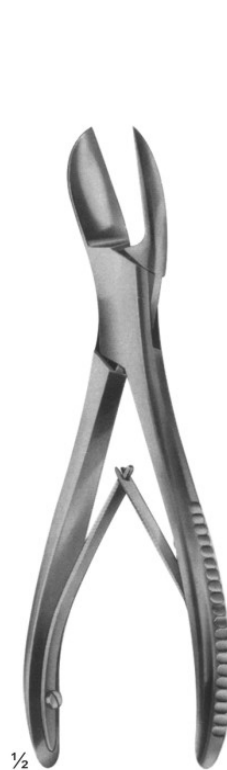

**06-8526 - 06-8528**  
LISTON



**06-8526**  
170 mm

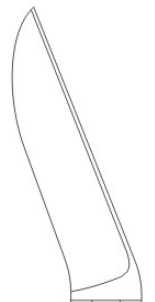

**06-8527**  
200 mm



**06-8528**  
220 mm

## Bone Cutting Forceps



**06-8529**  
BOEHLER  
145 mm

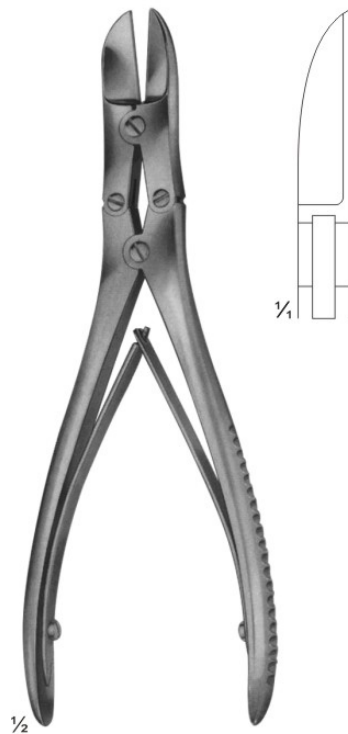

**06-8530**  
RUSKIN-LISTON  
190 mm



**06-8531**  
RUSKIN-LISTON  
190 mm



# Bone Cutting Forceps

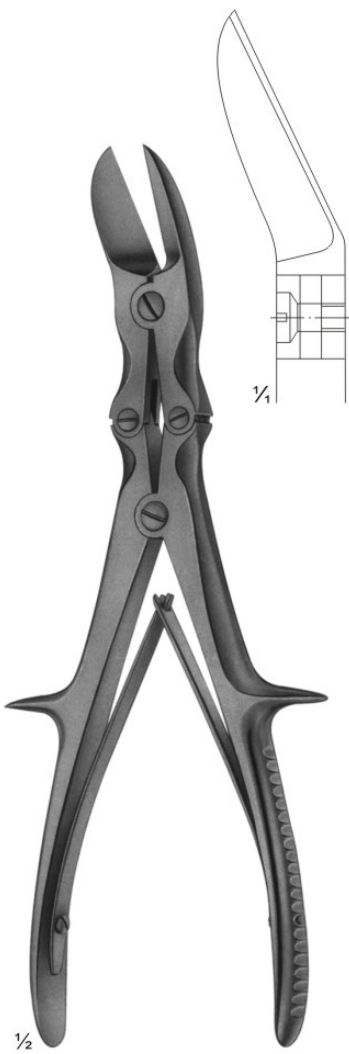

**06-8532**  
LISTON  
curved on flat  
240 mm

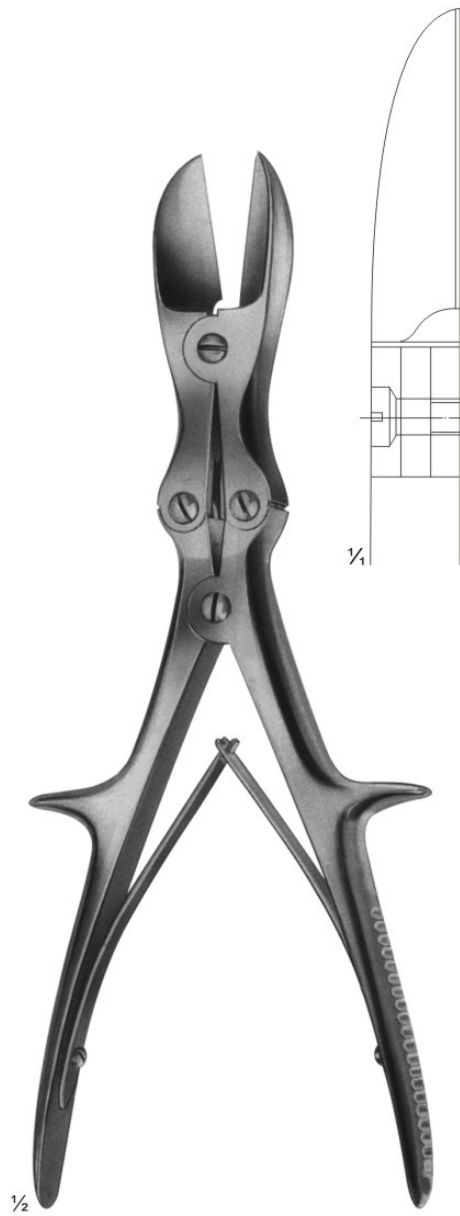

**06-8533**  
LISTON  
straight  
280 mm

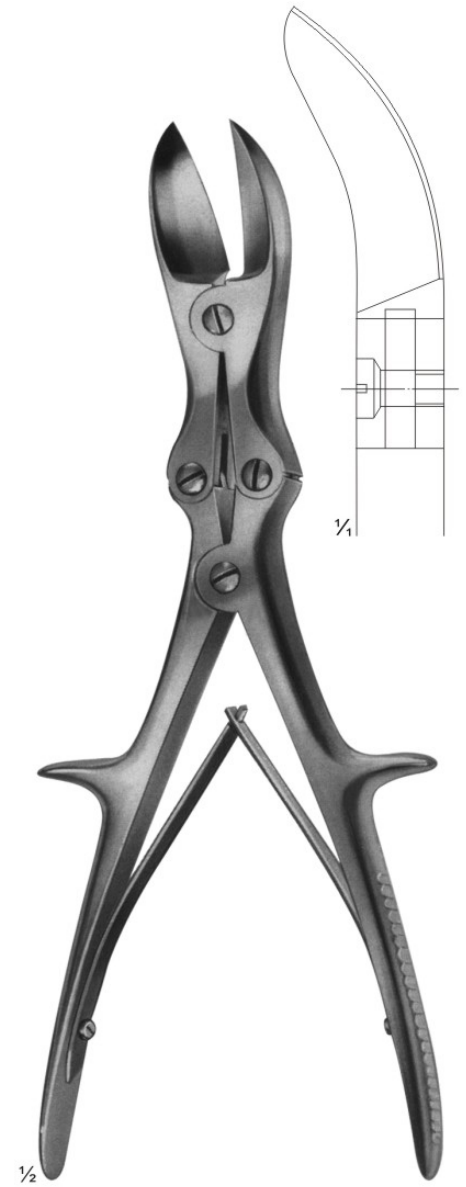

**06-8534**  
LISTON  
curved on flat  
280 mm

## Bone Cutting Forceps

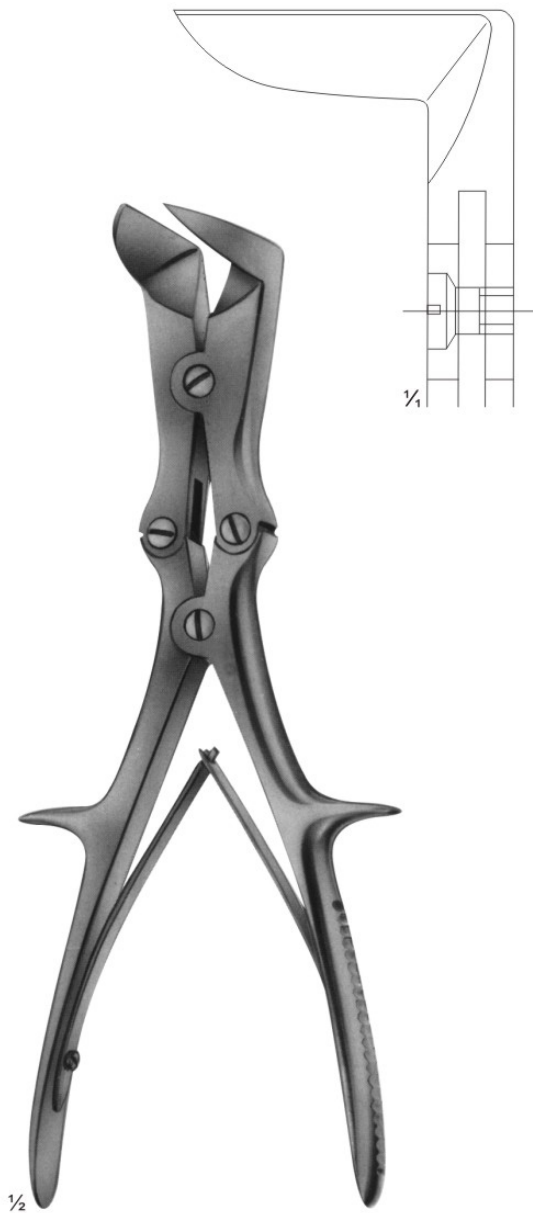

**06-8535**  
LISTON-STILLE  
265 mm

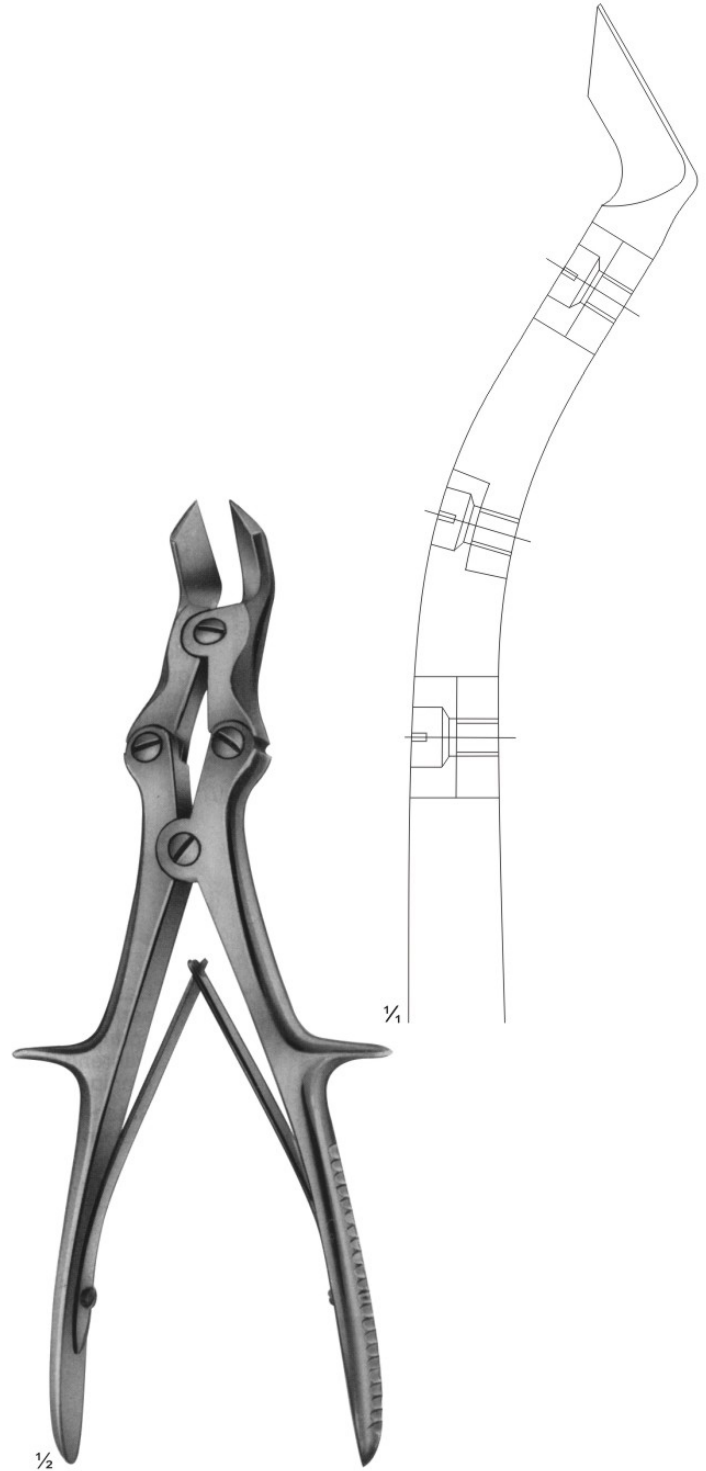

**06-8536**  
LISTON-KEY-HORSLEY  
(TUDOR EDWARDS)  
255 mm

## Meniscus-and Cartilage Forceps

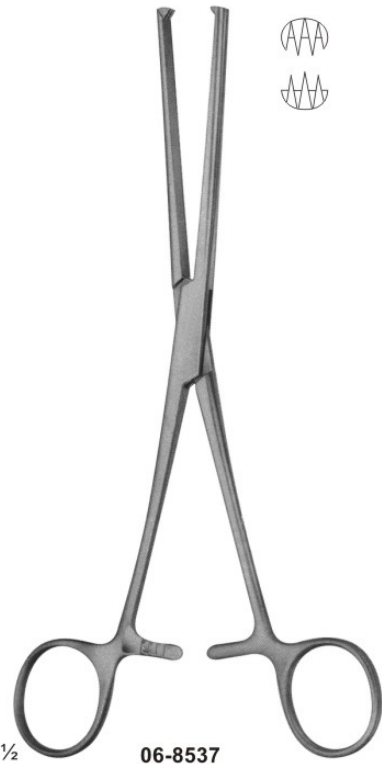

$\frac{1}{2}$  **06-8537**  
BIRCHER  
200 mm



$\frac{1}{2}$  **06-8538**  
BIRCHER  
200 mm

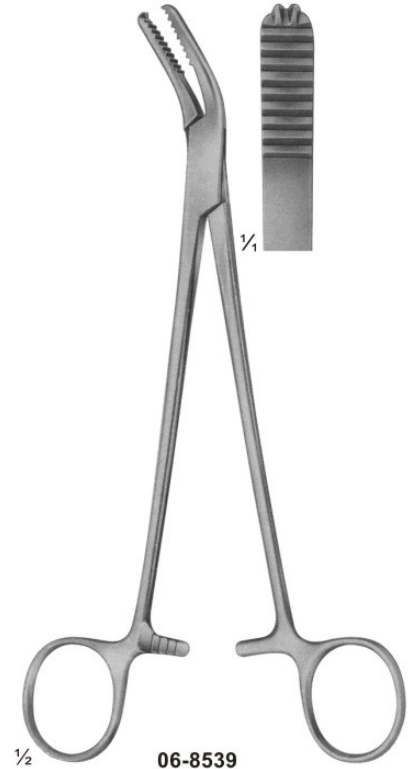

$\frac{1}{2}$  **06-8539**  
WELLER  
200 mm

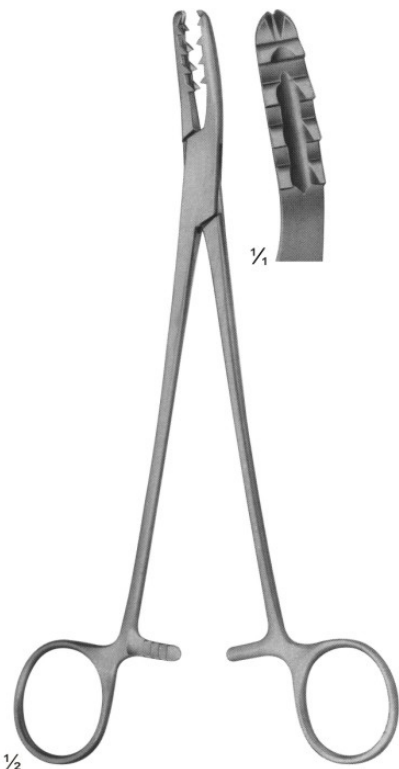

$\frac{1}{2}$  **06-8540**  
BIRCHER-GANSKE  
200 mm

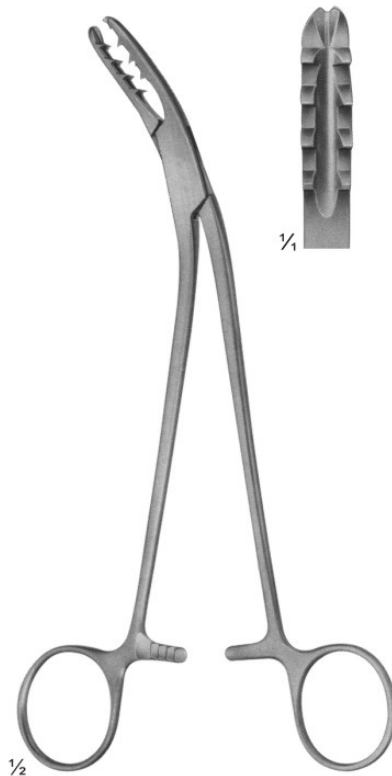

$\frac{1}{2}$  **06-8541**  
BIRCHER-GANSKE  
200 mm



$\frac{1}{2}$  **06-8542**  
MARTIN  
205 mm



# Meniscus Knives

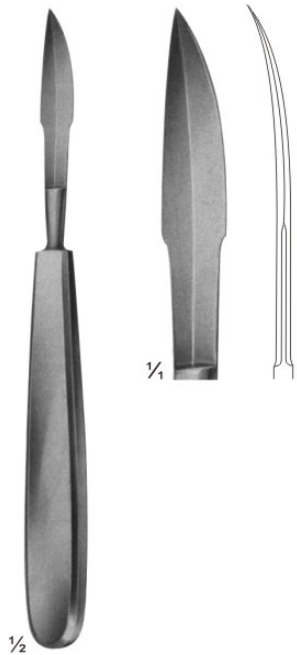

**06-8543**  
170 mm

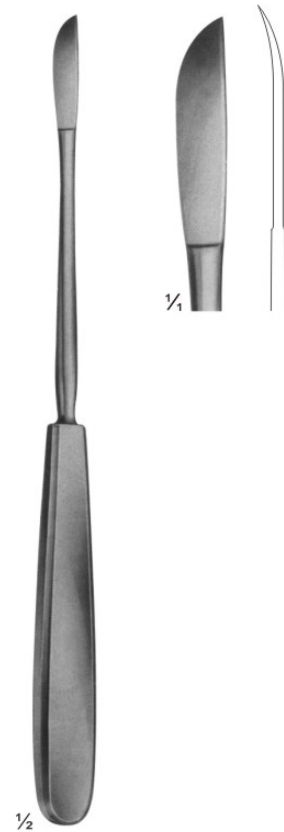

**06-8544**  
NEFF  
215 mm



**06-8545**  
NEFF  
215 mm



**06-8546**  
WAGNER  
215 mm

# Meniscus Knives

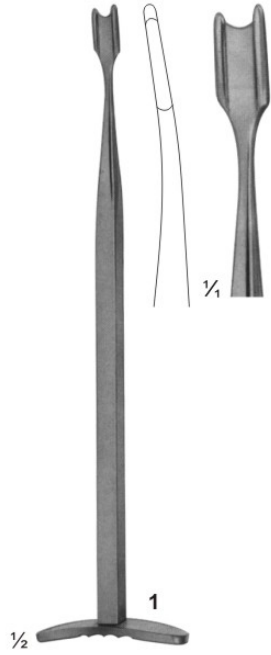

**06-8547**  
SMILLIE  
170 mm

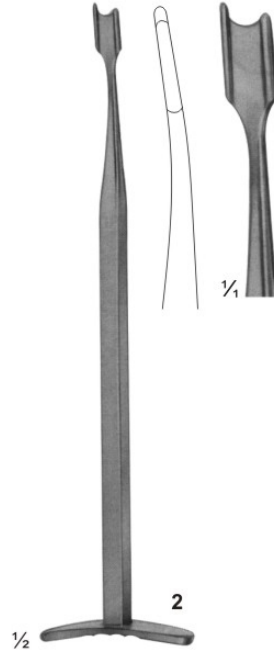

**06-8548**  
SMILLIE  
170 mm

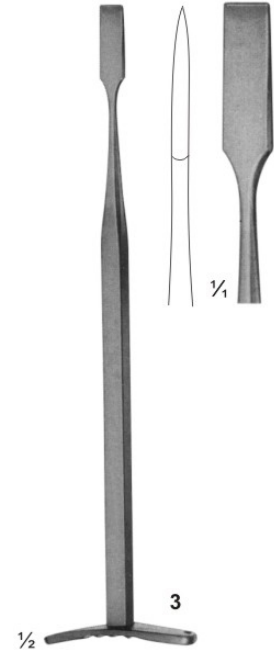

**06-8549**  
SMILLIE  
170 mm

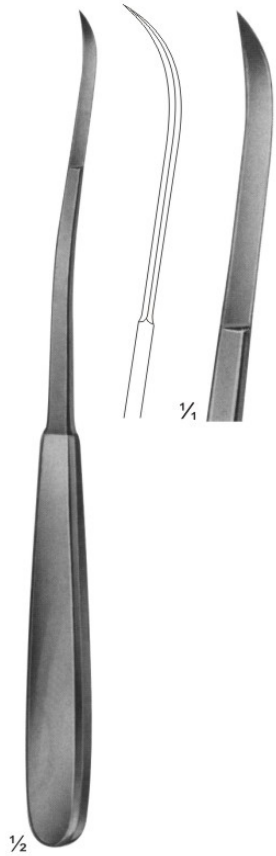

**06-8550**  
SALENIUS  
220 mm

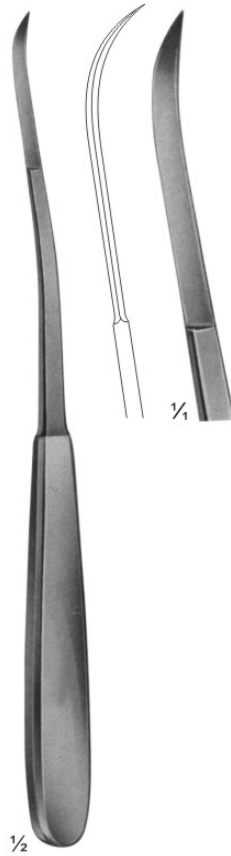

**06-8551**  
SALENIUS  
220 mm

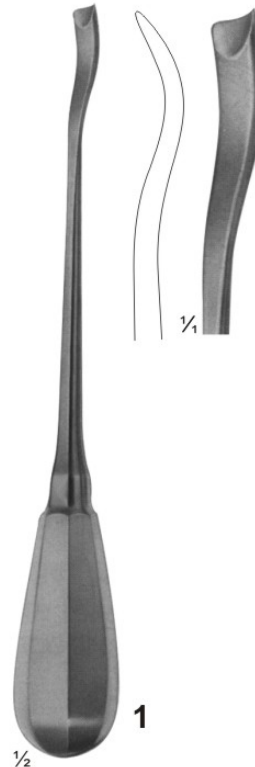

**06-8552**  
CANAD.MODELL  
200 mm

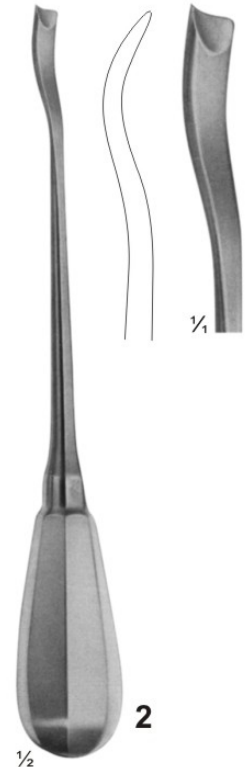

**06-8553**  
CANAD.MODELL  
200 mm

# Vacuum Currettes for Aspiration Lipectomy, Suction Instruments

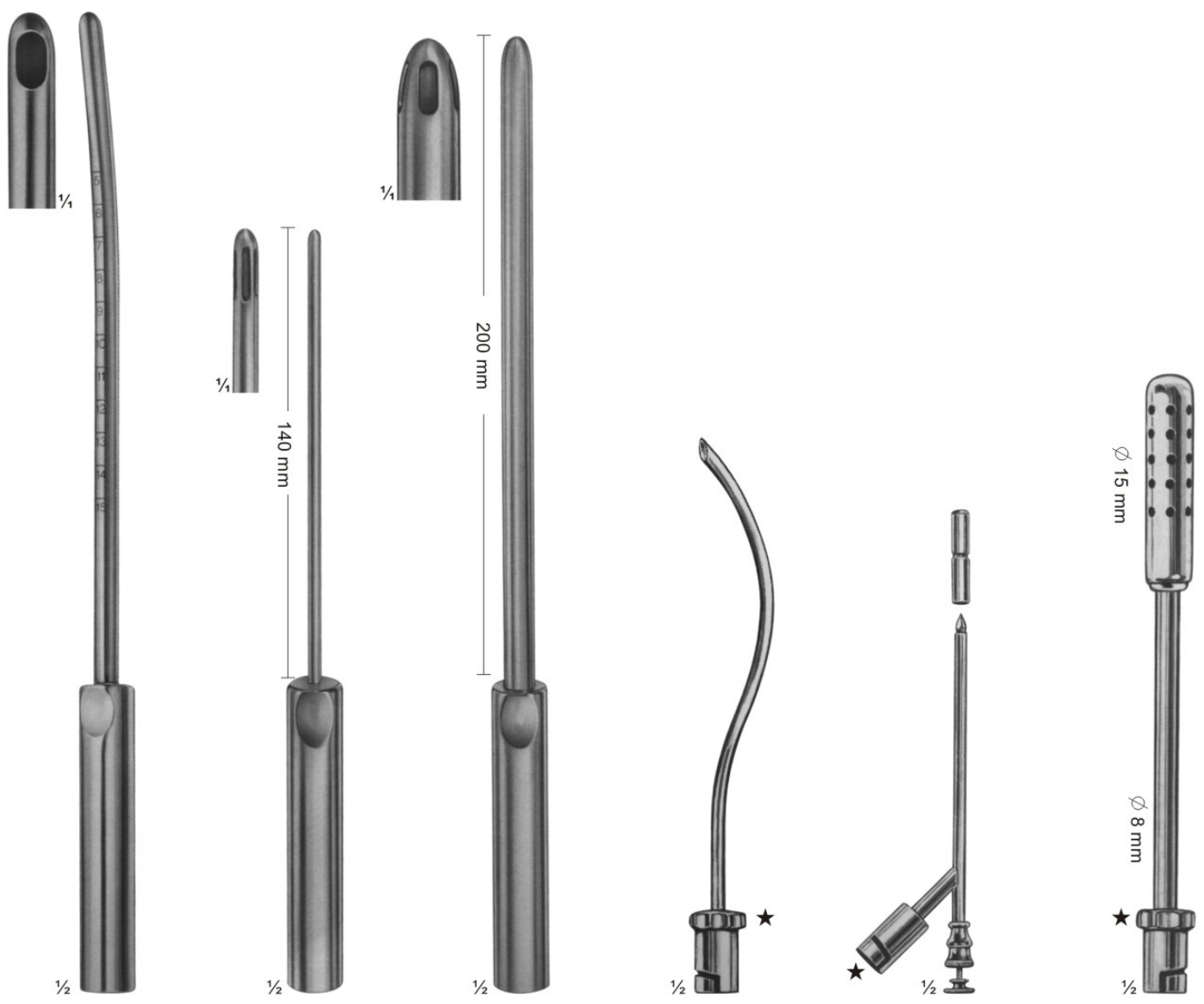

**07-9043 - 07-9048**  
BIEMER  
**07-9043** ∅ 4mm  
**07-9044** ∅ 6mm  
**07-9045** ∅ 8mm  
**07-9046** ∅ 10mm  
**07-9047** ∅ 12mm  
**07-9048** ∅ 14mm  
 Currettes for aspiration lipectomy, graduated, slightly curved

**07-9049 - 07-9050**  
BIEMER  
**07-9049** ∅ 4 mm  
**07-9050** ∅ 6 mm  
 Currettes for aspiration lipectomy, with three apertures, slightly curved malleable

**07-9051 - 07-9053**  
BIEMER  
**07-9051** ∅ 8 mm  
**07-9052** ∅ 10 mm  
**07-9053** ∅ 12 mm  
 Currettes for aspiration lipectomy, with three apertures, slightly curved malleable

**07-9054**  
For aspirating fluid from the excretory ducts of large glands and for keeping the operating area clear 170 mm

**07-9055**  
Trocar  
For puncturing 150 mm

**07-9056**  
For clearing large quantities of fluid 190 mm



# Suction Instruments

**07-9057** 150mm  
Suction handle, with vacuum regulator and finger cut-off, brass, mirror-finish chromium-plated

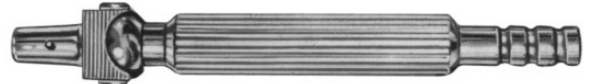

olive  
Ø9 mm

**07-9058** 170mm  
Suction handle, with hand regulation valve and quick-shutter, brass, mirror-finish chromium-plated



★ Both suction handles have bayonet fitting olive and can be used for the suction cannulae. Ø9 mm

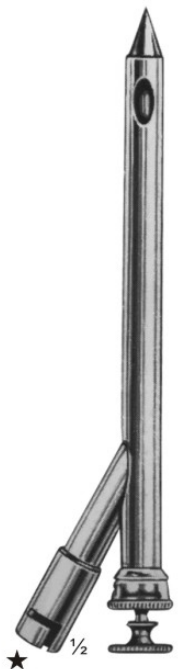

**07-9059**  
Trocar  
For puncturing  
170 mm



**07-9060**  
Hollow needle,  
sharp  
150 mm



**07-9061**  
double curved  
For general  
surgery  
230 mm

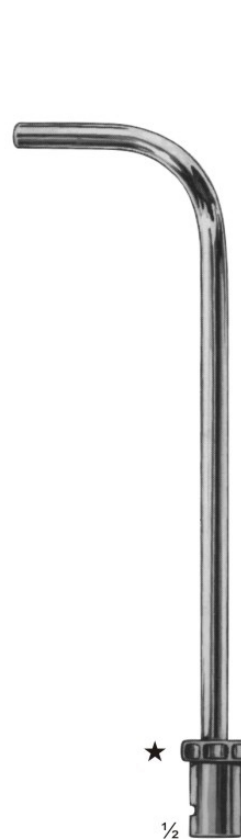

**07-9062**  
For tonsillectomy,  
oral and laryngeal  
operations  
190 mm



**07-9063**  
For tonsillectomy,  
oral and laryngeal  
operations  
220 mm

★ With bayonet fitting to be used with suction handles (07-9057 - 07-9058)

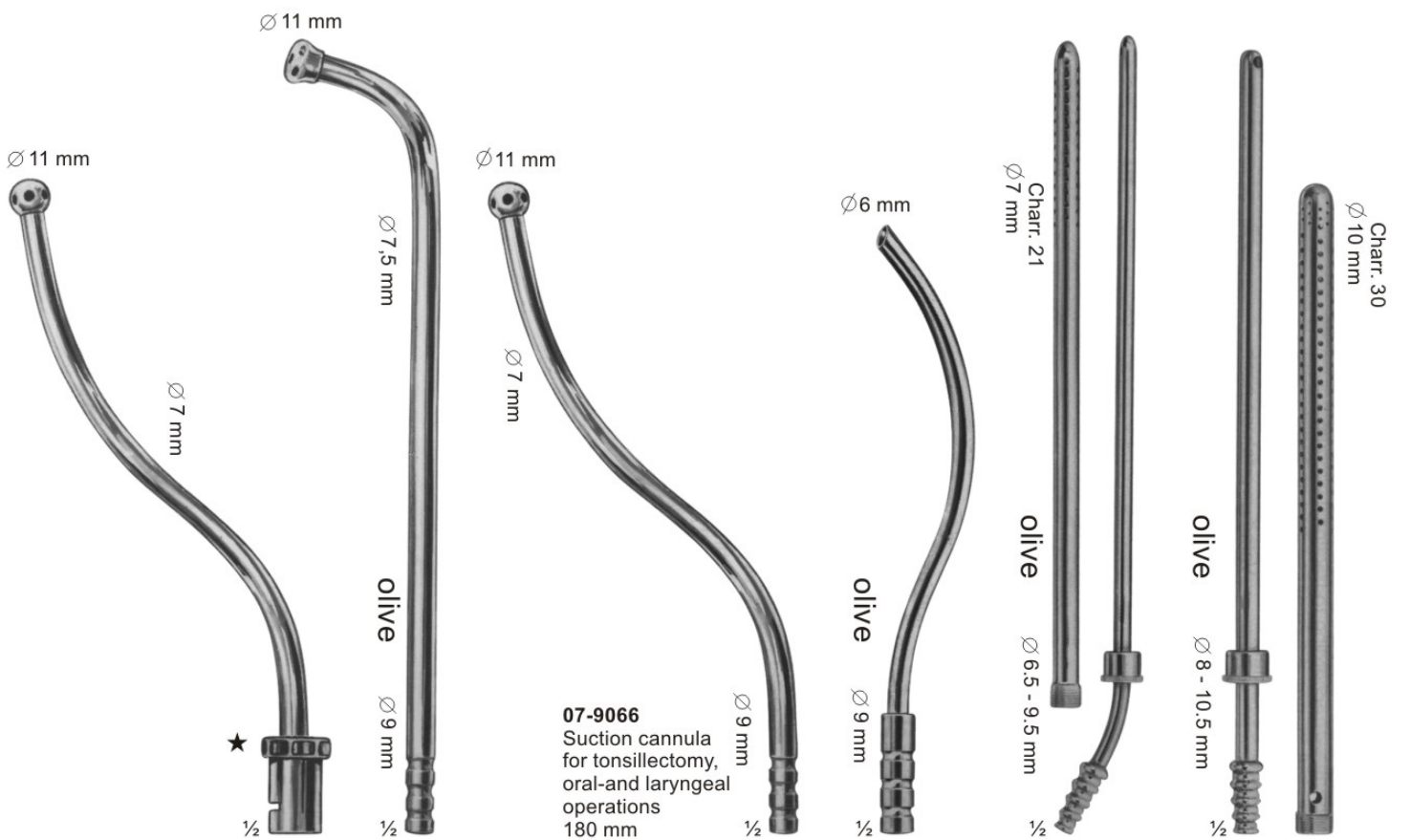

**07-9064**  
For tonsillectomy,  
oral-and laryngeal  
operations  
180 mm

**07-9065**  
Suction cannula  
for tonsillectomy,  
oral-and laryngeal  
operations  
220 mm

**07-9066**  
Suction cannula  
for tonsillectomy,  
oral-and laryngeal  
operations  
180 mm

**07-9067**  
S-shaped blunt cannula  
for aspirating fluid from  
the excretory ducts of  
large glands and for  
keeping the operating  
area clear  
170 mm

**07-9068**  
POOL  
Suction cannula,  
with outer tube  
to be screwed of  
225 mm

**07-9069**  
POOL  
Suction cannula,  
with outer tube  
to be screwed off  
225 mm

# Suction Instruments

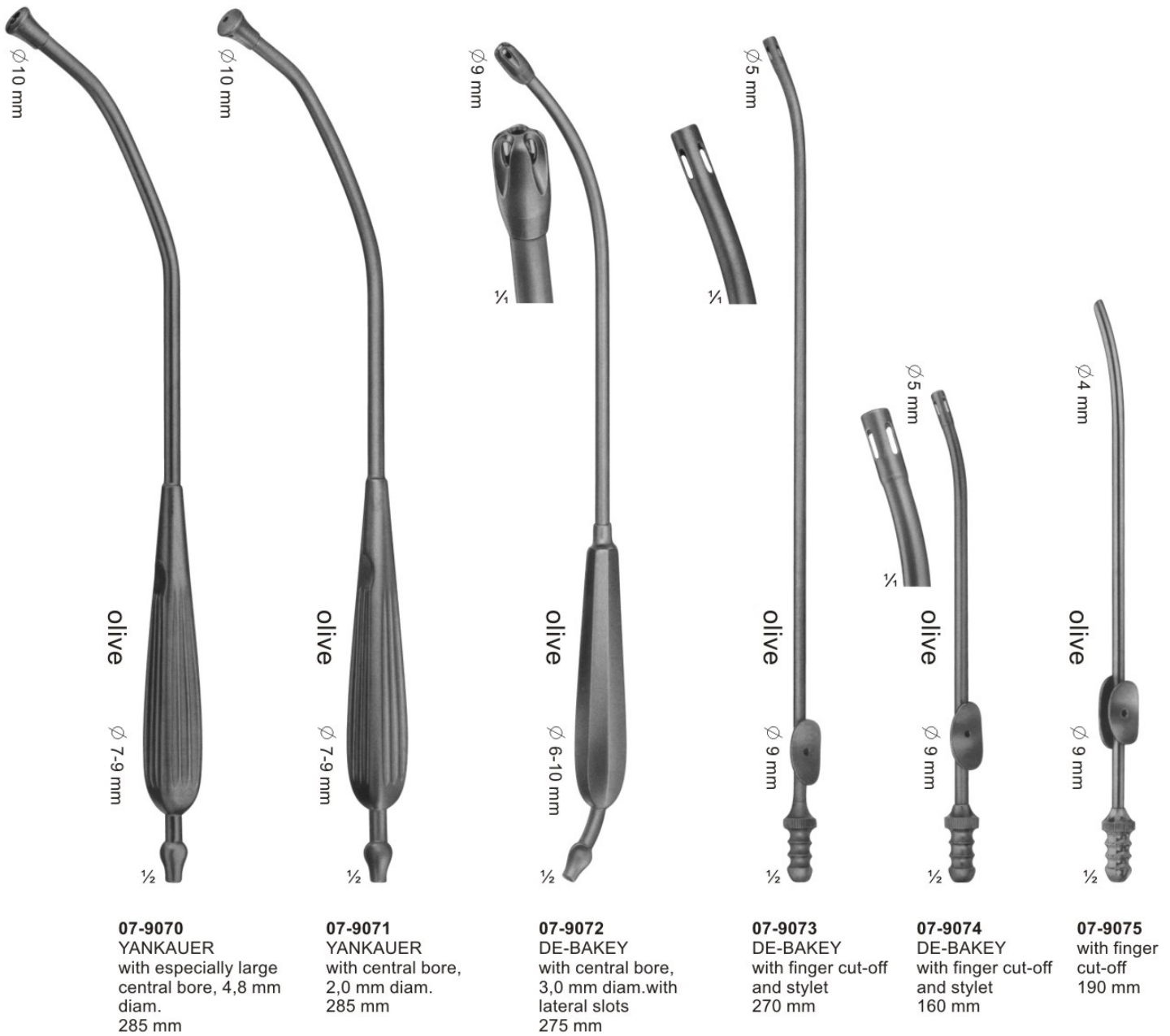

**07-9070**  
YANKAUER  
with especially large  
central bore, 4,8 mm  
diam.  
285 mm

**07-9071**  
YANKAUER  
with central bore,  
2,0 mm diam.  
285 mm

**07-9072**  
DE-BAKEY  
with central bore,  
3,0 mm diam.with  
lateral slots  
275 mm

**07-9073**  
DE-BAKEY  
with finger cut-off  
and stylet  
270 mm

**07-9074**  
DE-BAKEY  
with finger cut-off  
and stylet  
160 mm

**07-9075**  
with finger  
cut-off  
190 mm



# Suction Instruments



olive  
Ø 6-9 mm  
1/2

- 07-9076 Ø 1,5 mm
- 07-9077 Ø 2,0 mm
- 07-9078 Ø 2,5 mm
- 07-9079 Ø 3,0 mm

**07-9076 - 07-9079**  
PLESTER  
with finger cut-off and  
stylet, thumb piece  
parallel to curve, with  
LUER hub  
195 mm

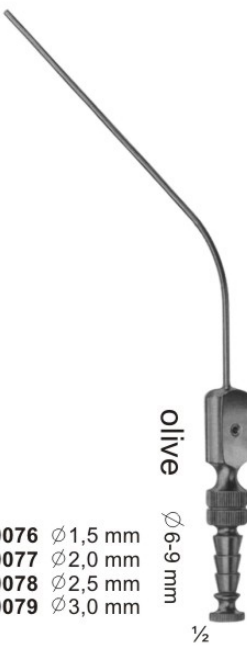

olive  
Ø 6-9 mm  
1/2

- 07-9080 Ø 2,0 mm
- 07-9081 Ø 2,5 mm
- 07-9082 Ø 3,0 mm
- 07-9083 Ø 4,0 mm
- 07-9084 Ø 5,0 mm

**07-9080 - 07-9084**  
FERGUSSON  
with finger cut-off and  
stylet, thumb piece  
90° to curve, with  
LUER hub  
180 mm



olive  
Ø 6-9 mm  
1/2

**07-9085** Ø 4mm  
FERGUSSON  
insulated, with finger cut-off  
and stylet, thumb piece 90°  
to curve, with LUER hub  
180 mm



olive  
Ø 6-9 mm  
1/2

**07-9086** Ø 3mm  
**07-9087** Ø 5mm  
FRAZIER  
with finger  
cut-off and stylet, thumb  
piece 90° to curve,  
with LUER hub  
180 mm

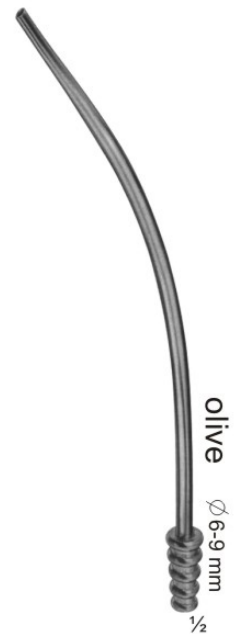

olive  
Ø 6-9 mm  
1/2

**07-9088**  
5,0 mm diam., Tip  
6,5 mm wide, Nasal  
suction tube, with  
LUER hub  
180 mm



1/2

**07-9089** 4,5mm  
**07-9090** 5,5mm  
Nasal suction  
tubes  
175 mm



1/2

**07-9091**  
GORNEY  
Suction dissector  
180 mm



olive  
Ø 6-10 mm  
1/2

**07-9092** 4 mm wide  
**07-9093** 5 mm wide  
Suction raspatories,  
sharp, bayonet-shaped,  
with stylet  
200 mm



olive  
Ø 9 mm  
1/2

**07-9094**  
LOPEZ-REINKE  
Tonsil dissector with  
suction device  
235 mm

# Suction Instruments

**07-9095**  
**WULLSTEIN**  
 Suction tube, conical, silver, olive  
 with LUER hub  
 160 mm



**07-9096** 1,5 mm  
**07-9097** 2,0 mm  
**WULLSTEIN**  
 Suction tube, cylindrical, silver, with  
 stylet olive with LUER hub  
 160 mm



Usable length

YASARGIL usable length diam.		YASARGIL usable length diam.	
<b>07-9098</b>	130 mm 1,5 mm	<b>07-9106</b>	130 mm 2,5 mm
<b>07-9099</b>	150 mm 1,5 mm	<b>07-9107</b>	150 mm 2,5 mm
<b>07-9100</b>	180 mm 1,5 mm	<b>07-9108</b>	180 mm 2,5 mm
<b>07-9101</b>	220 mm 1,5 mm	<b>07-9109</b>	220 mm 2,5 mm
<b>07-9102</b>	130 mm 2,0 mm	<b>07-9110</b>	130 mm 3,5 mm
<b>07-9103</b>	150 mm 2,0 mm	<b>07-9111</b>	150 mm 3,5 mm
<b>07-9104</b>	180 mm 2,0 mm	<b>07-9112</b>	180 mm 3,5 mm
<b>07-9105</b>	220 mm 2,0 mm	<b>07-9113</b>	220 mm 3,5 mm
		<b>07-9114</b>	180 mm 4,5 mm

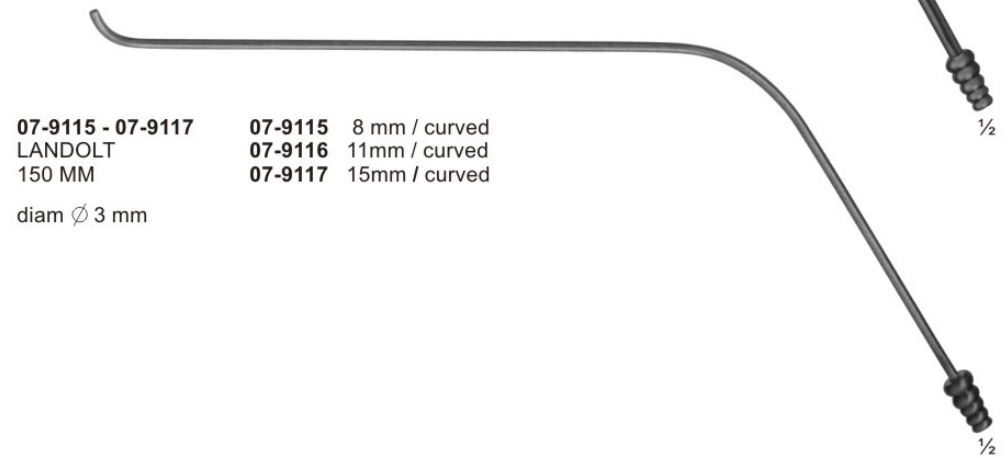

**07-9115 - 07-9117**  
**LANDOLT**  
 150 MM  
 diam Ø 3 mm

**07-9115** 8 mm / curved  
**07-9116** 11mm / curved  
**07-9117** 15mm / curved

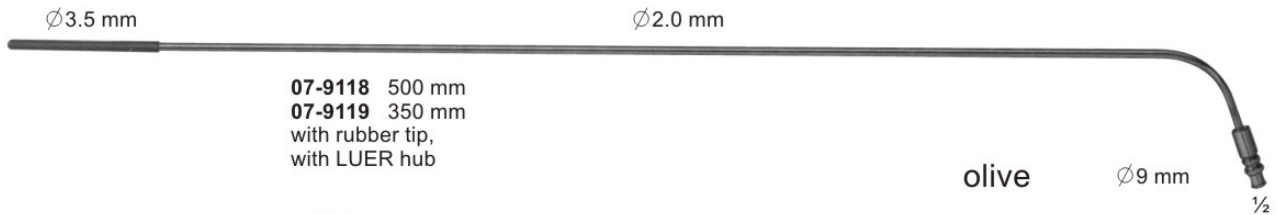

**07-9120** 2,0 mm diam  
**07-9121** 2,5 mm diam  
**07-9122** 3,0 mm diam  
 with finger cut-off,  
 thumb piece 90° to  
 curve, with LUER hub  
 250 mm

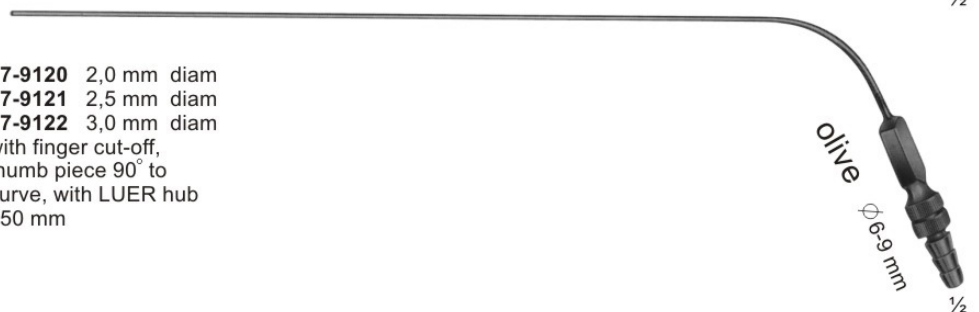

# Punches

## Angled positions for punchus

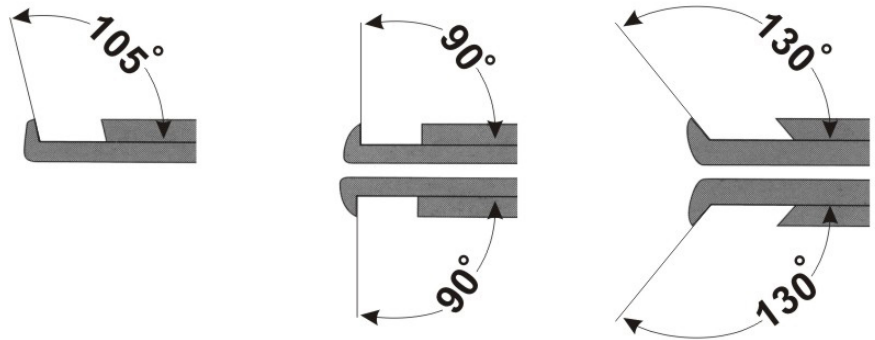

**90°** upwards cutting

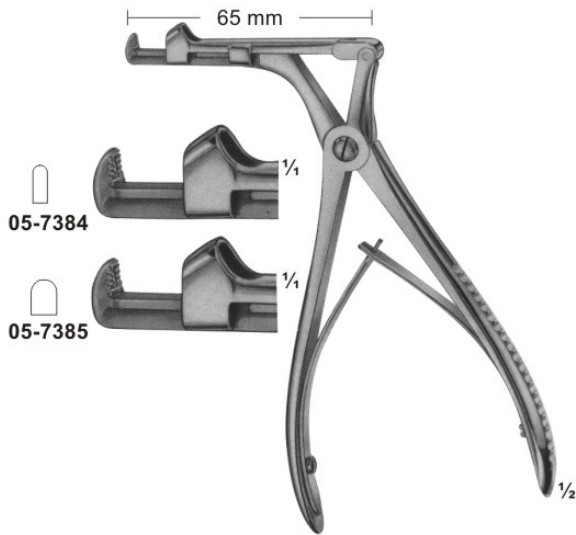

**05-7384 - 05-7385**  
CITELLI  
05-7384 2mm  
05-7385 3.5mm

**90°** upwards cutting

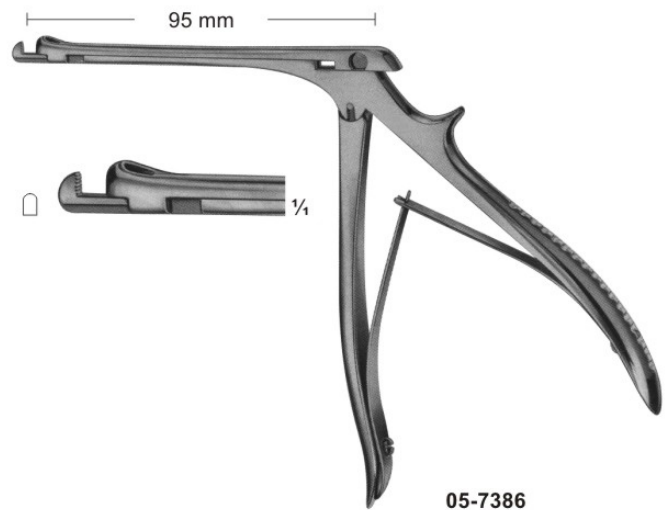

**05-7386**  
CITELLI- BEYER  
1,8 mm



# Punches

90° upwards cutting

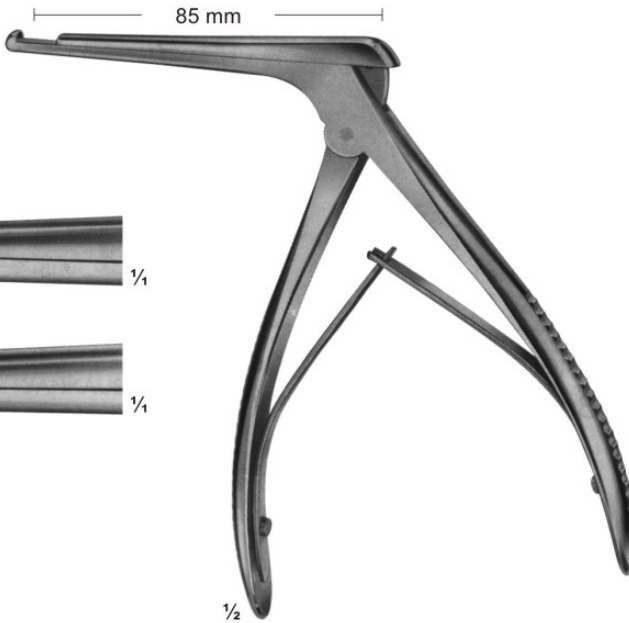

05-7387  
4 mm



05-7388  
5 mm



05-7387 - 05-7388  
KERRISON

90° upwards cutting

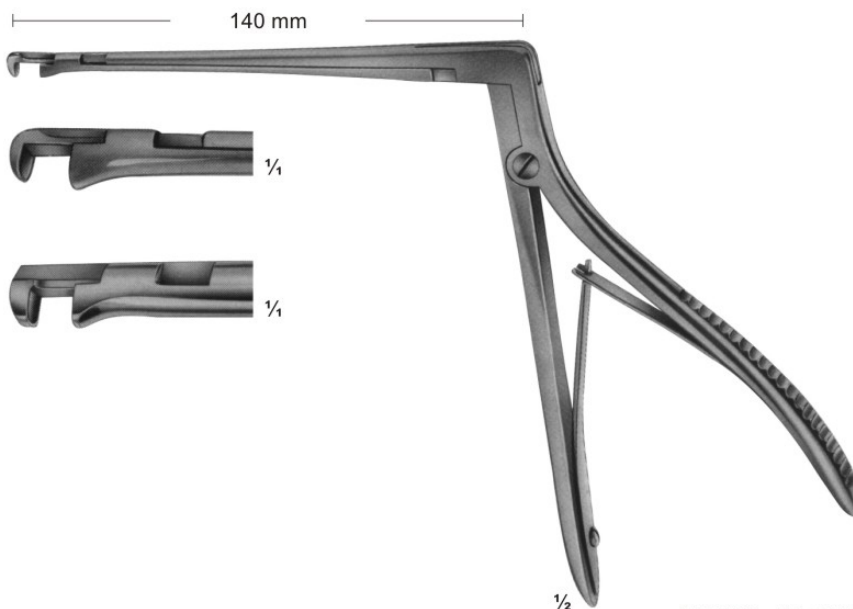

05-7389  
3,3 mm



05-7390  
4,0 mm



05-7389 - 05-7390  
HAJEK-KOFLER

# Punches

**130°** upwards cutting

KERRISON-JACOBY

**05-7391**  
1 mm 

FERRIS-SMITH-KERRISON

**05-7392**  
2 mm 

**05-7393**  
3 mm 

**05-7394**  
4 mm 

**05-7395**  
5 mm 

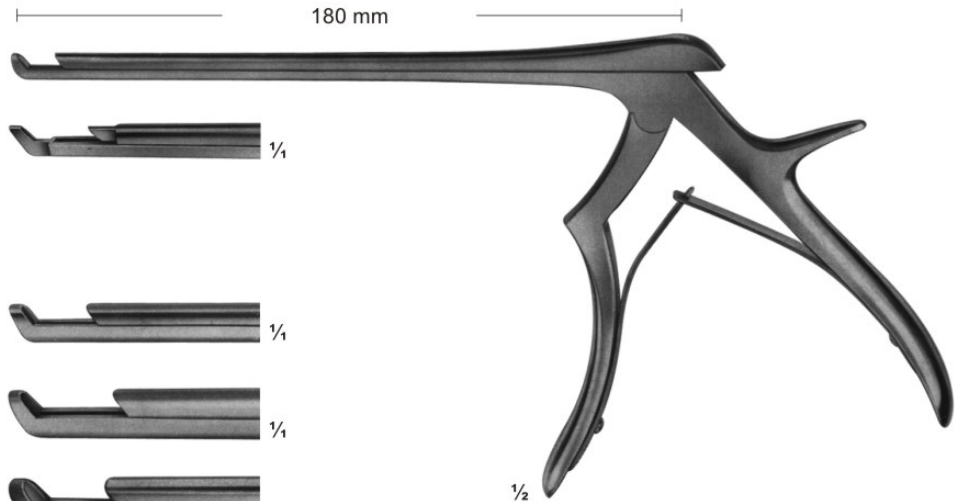

05-7391 - 05-7395

**90°** upwards cutting

KERRISON-JACOBY

**05-7396**  
1 mm 

**05-7397**  
2 mm 

FERRIS-SMITH-KERRISON

**05-7398**  
3 mm 

**05-7399**  
4 mm 

**05-7400**  
5 mm 

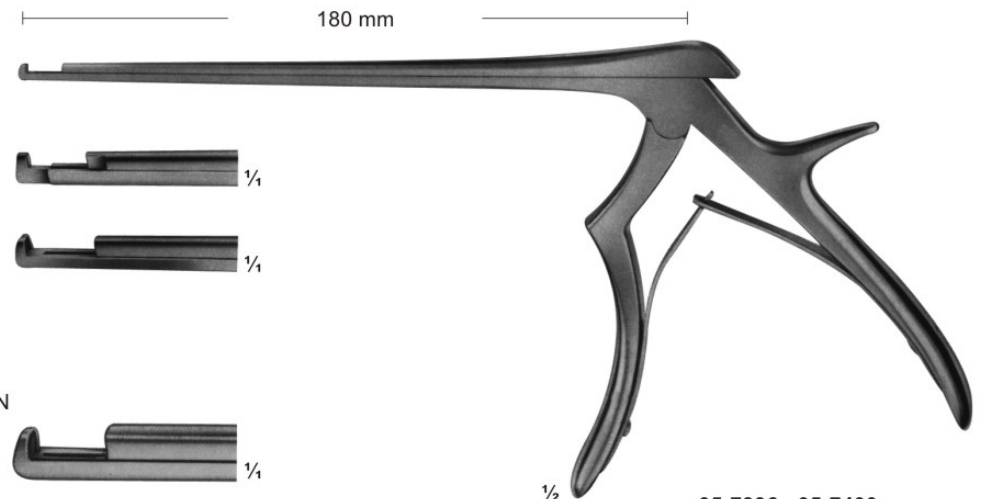

05-7396 - 05-7400

# Rongeurs

Angled positions for rongeurs

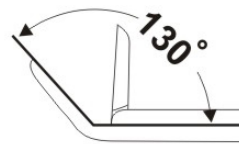
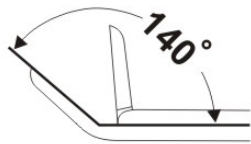
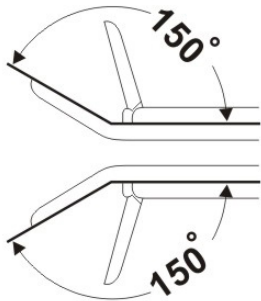

**05-7401**  
3,0 mm

**05-7402**  
3,6 mm

**05-7403**  
4,2 mm

**05-7404**  
4,8 mm

**05-7405**  
5,8 mm

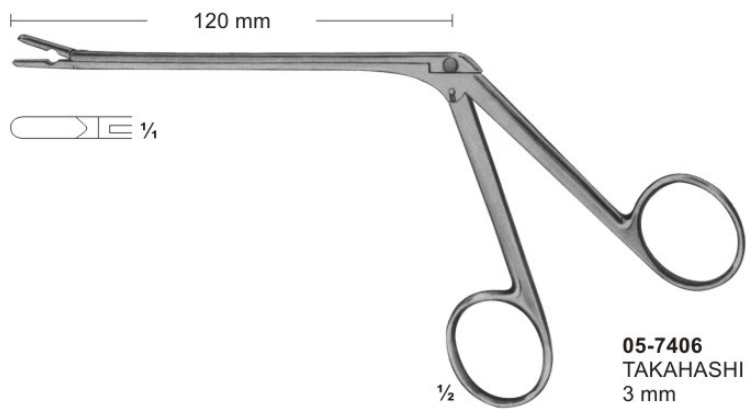
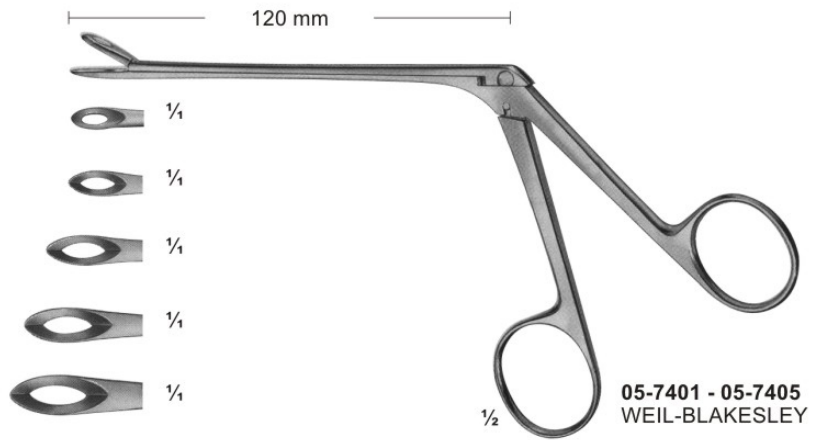

**130°**

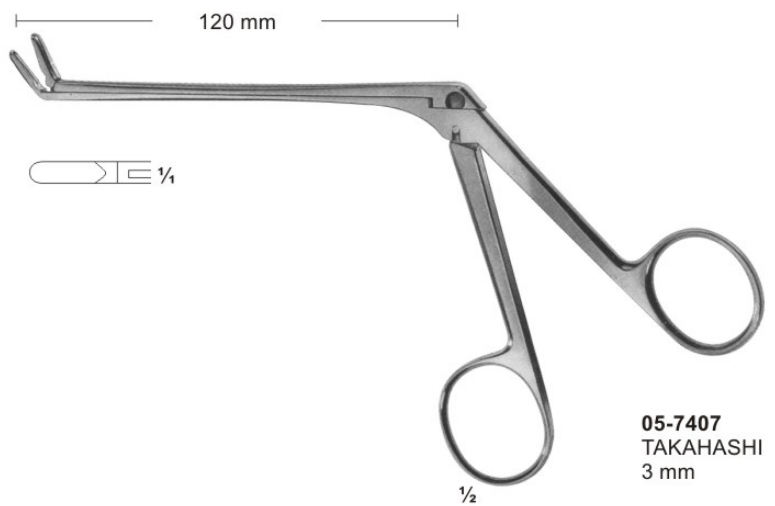



# Rongeurs

LOVE-GRUENWALD

**05-7408**  
2 X 10 mm

**05-7409**  
3 X 10 mm

SPURLING

**05-7410**  
4 X 10 mm

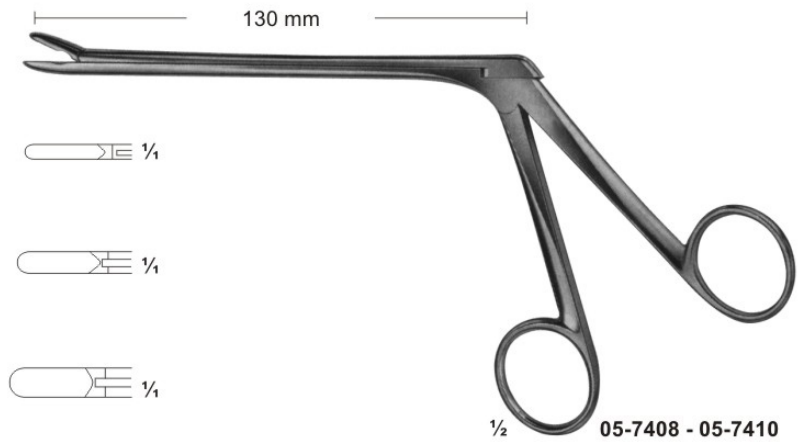

1/2 **05-7408 - 05-7410**

**05-7411**  
2 mm

**05-7412**  
3 mm

**05-7413**  
4 mm

**05-7414**  
5 mm

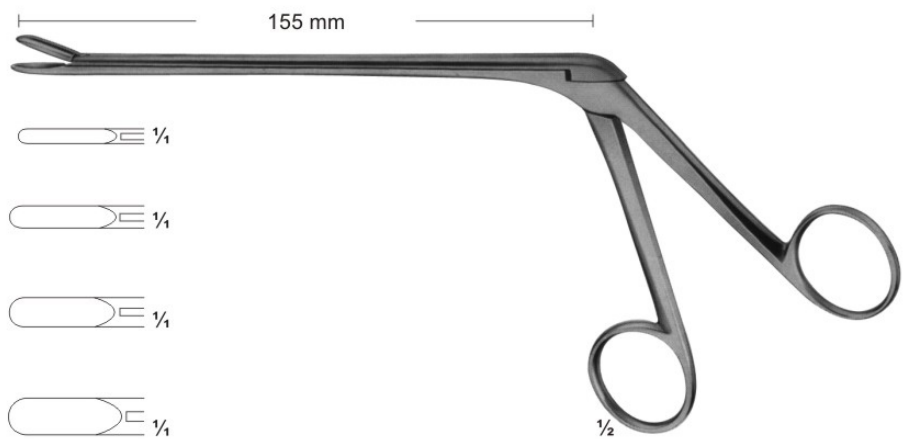

**05-7411 - 05-7414**  
CASPAR

**150°**

**05-7415**  
2 mm

**05-7416**  
3 mm

**05-7417**  
4 mm

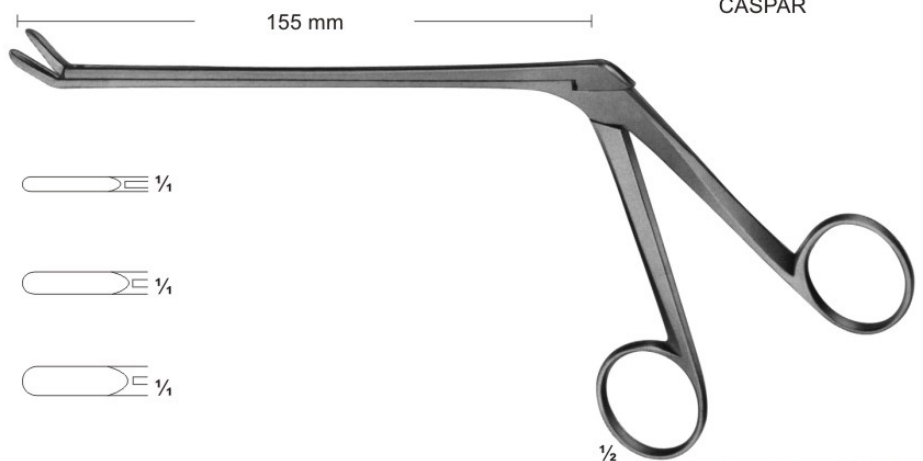

**05-7415 - 05-7417**  
CASPAR

# Rongeurs

**150°**

Lower part of jaws movable

**05-7418**  
2 mm

**05-7419**  
3 mm

**05-7420**  
4 mm

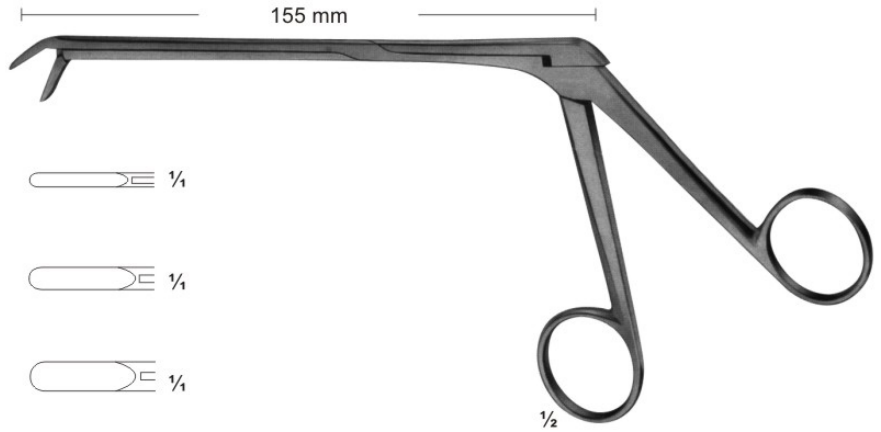

**05-7418 - 05-7420**  
CASPAR

Length of shaft 140 mm	Length of shaft 160 mm	Length of shaft 185 mm	size of jaws
<b>05-7421</b>	<b>05-7426</b>	<b>05-7431</b>	2 X12 mm
<b>05-7422</b>	<b>05-7427</b>	<b>05-7432</b>	3 X12 mm
<b>05-7423</b>	<b>05-7428</b>	<b>05-7433</b>	4 X14 mm
<b>05-7424</b>	<b>05-7429</b>	<b>05-7434</b>	5 X14 mm
<b>05-7425</b>	<b>05-7430</b>	<b>05-7435</b>	6 X16 mm

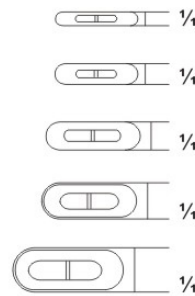

**05-7421 - 05-7435**  
CASPAR

**150°**

Length of shaft 140 mm	Length of shaft 160 mm	Length of shaft 185 mm	size of jaws
<b>05-7436</b>	<b>05-7439</b>	<b>05-7442</b>	3 X12 mm
<b>05-7437</b>	<b>05-7440</b>	<b>05-7443</b>	4 X14 mm
<b>05-7438</b>	<b>05-7441</b>	<b>05-7444</b>	5 X14 mm

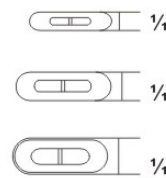

**05-7436 - 05-7444**  
CASPAR

# Rongeurs

**150°**

Lower part of jaw movable

Length of shaft 140 mm	Length of shaft 160 mm	Length of shaft 185 mm	size of jaws
<b>05-7445</b>	<b>05-7447</b>	<b>05-7449</b>	3 X 12 mm
<b>05-7446</b>	<b>05-7448</b>	<b>05-7450</b>	4 X 14 mm

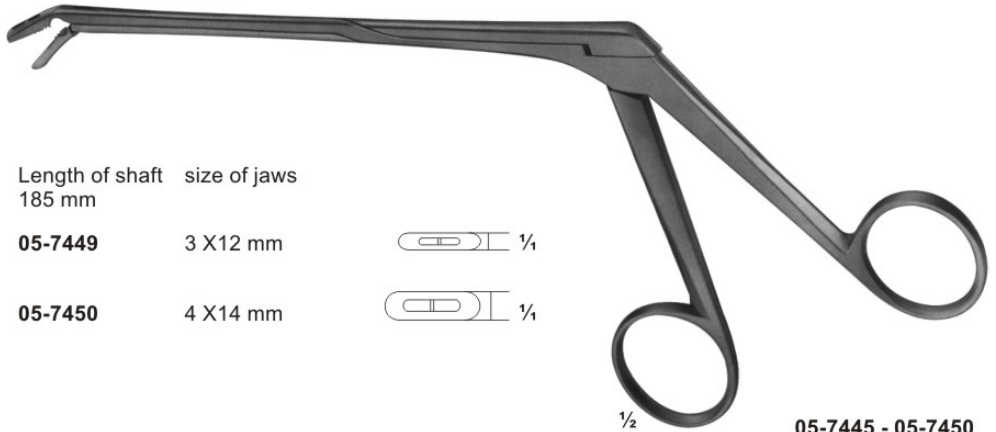
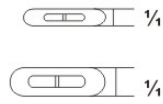

**05-7445 - 05-7450**  
CASPAR

**05-7451**  
2 X 10 mm  
CUSHING



**05-7452**  
3 X 10 mm  
LOVE-GRUENWALD

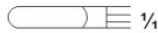

**05-7453**  
4 X 10 mm  
SPURLING

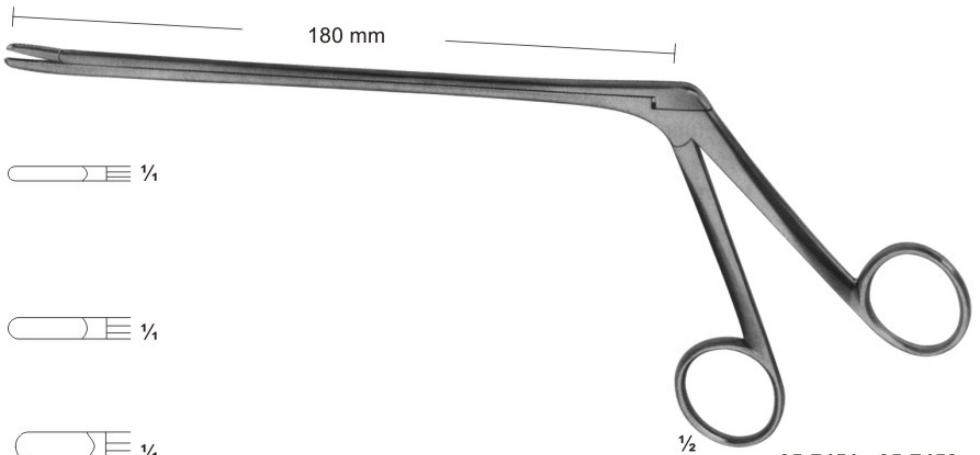

**05-7451 - 05-7453**

**150°**

**05-7454**  
3 X 10 mm  
LOVE-GRUENWALD



**05-7455**  
4 X 10 mm  
SPURLING

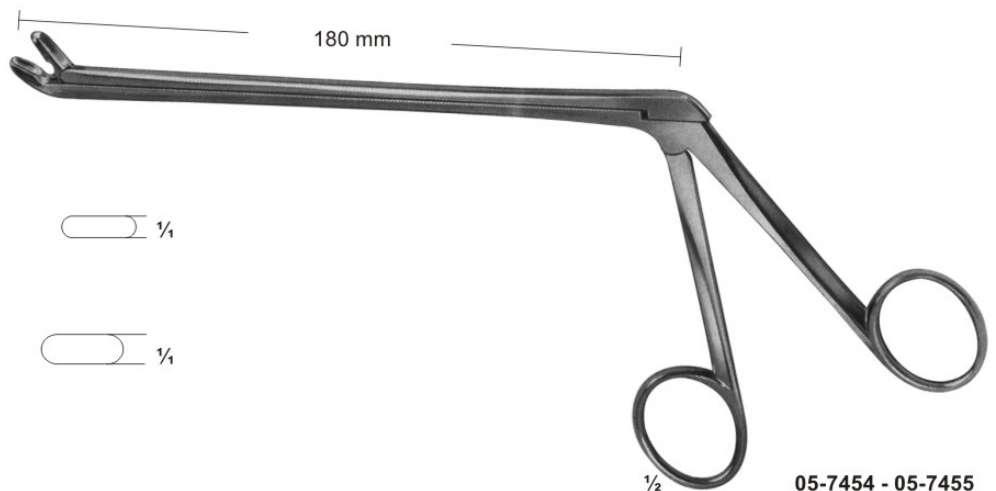

**05-7454 - 05-7455**



# Rongeurs

**150°**

Upper part of jaw  
movable

**05-7456**  
3 X 10 mm  
LOVE-GRUENWALD

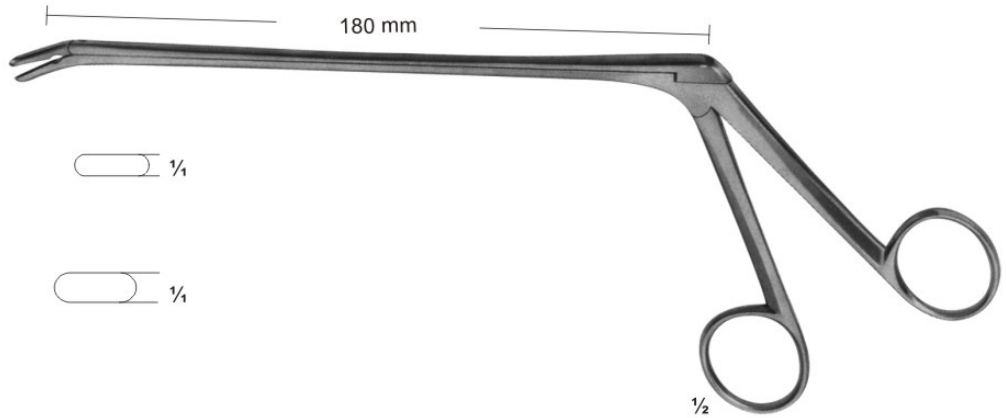

05-7456 - 05-7457

**05-7457**  
4 X 10 mm  
SPURLING



**05-7458**  
∅ 7 mm

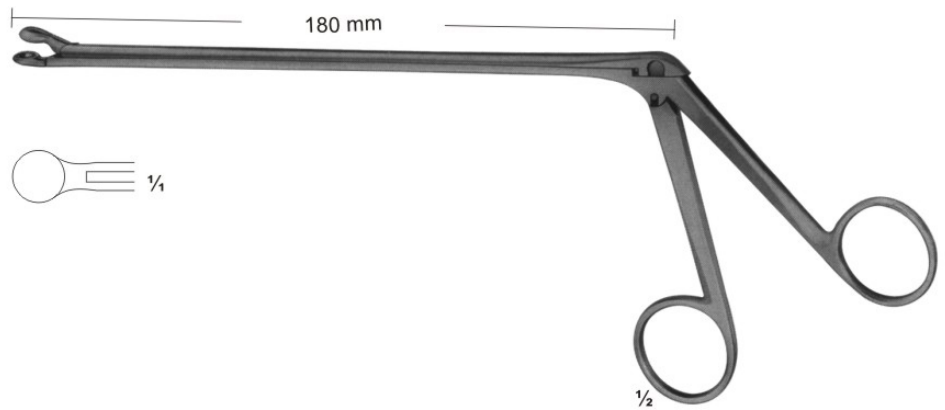

05-7458  
OLDBERG

**05-7459**  
YASARGIL  
∅ 2,2 mm

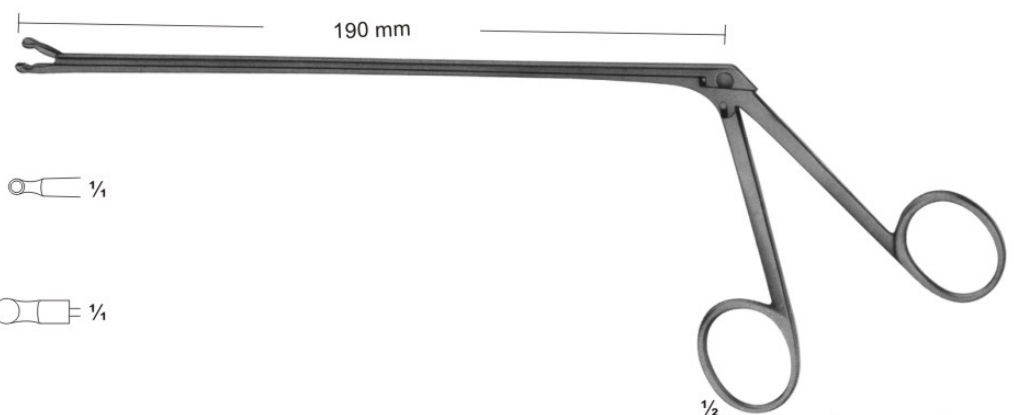

05-7459 - 05-7460

**05-7460**  
YASARGIL  
∅ 3,5 mm



# Rongeurs

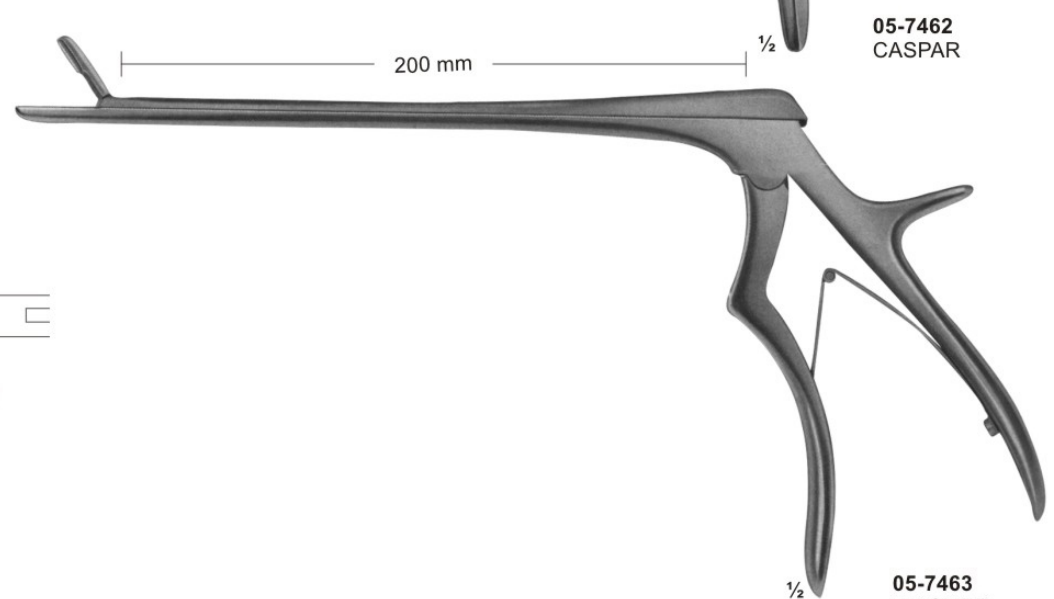
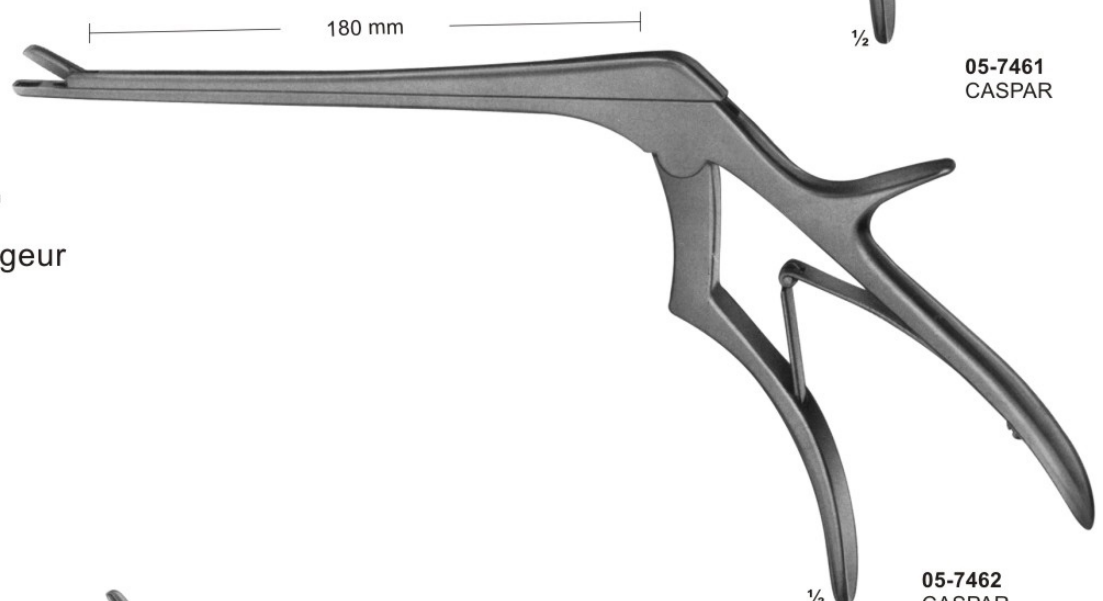
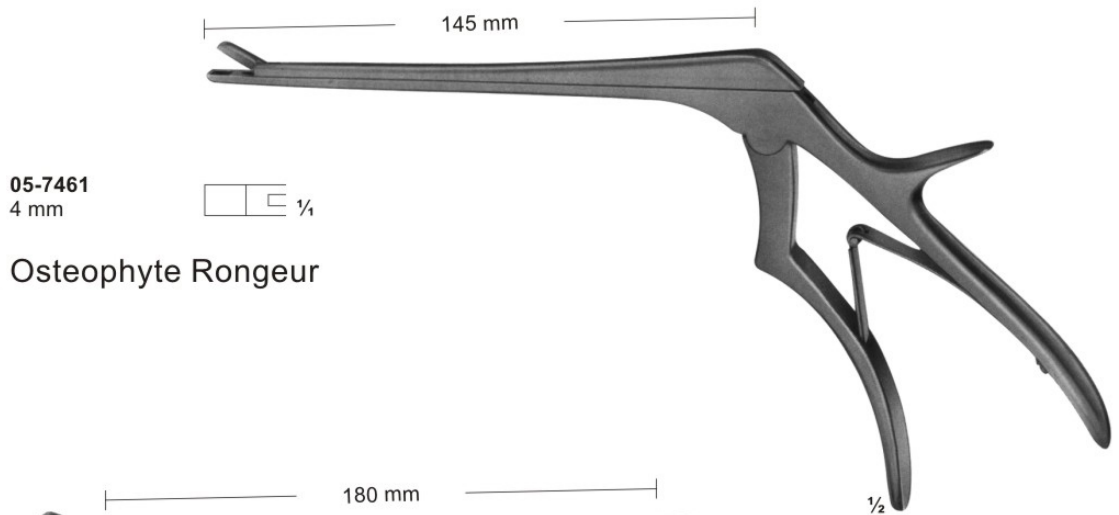

# Plaster Instruments

## Plaster Knives



with ebony handle

**07-9001**  
HOPKINS  
200 mm



**07-9002**  
ESMARCH  
180 mm

## Plaster Saw



**07-9003**  
ENGEL  
160 mm

## Bandage and First-Aid scissors



1/2

**07-9004 - 07-9012** 145mm

<b>07-9004</b> black	<b>07-9008</b> yellow
<b>07-9005</b> red	<b>07-9009</b> white
<b>07-9006</b> blue	<b>07-9010</b> orange
<b>07-9007</b> light green	<b>07-9011</b> violet
	<b>07-9012</b> bright pink



1/2

**07-9013 - 07-9021** 180mm

<b>07-9013</b> black	<b>07-9017</b> yellow
<b>07-9014</b> red	<b>07-9018</b> white
<b>07-9015</b> blue	<b>07-9019</b> orange
<b>07-9016</b> light green	<b>07-9020</b> violet
	<b>07-9021</b> bright pink



# Plaster Scissors

For small plaster dressings



# Plaster Shears

**Special features:**

The construction of the open jaws avoids tiresome clogging by plaster remnants and allows furthermore an easy cleaning. The shears do not glide off the plaster owing to the deep teething on the jaws. The knives with hollow grinding have a better cutting ability and therefore less force is required. The knives are guided by ball bearings.

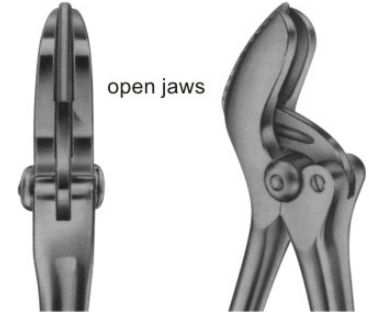

open jaws



**07-9029A**

Spare blade

open jaws

1/2

**07-9029**  
STILLE  
260 mm



**07-9031**

Spare blade

open jaws

1/2

**07-9030**  
STILLE  
360 mm

## STILLE Plaster Shears

Blade with reinforced back



**07-9032**  
STILLE  
230 mm

**07-9033**  
Spare blade



**07-9034**  
STILLE  
370 mm

**07-9035**  
Spare blade



**07-9036**  
STILLE  
240 mm

**07-9037**  
Spare blade

# Plaster Spreader, Plaster Breakers



**07-9038**  
HENNIG  
270 mm



**07-9039**  
MOD.USA  
230 mm



**07-9040**  
290 mm



with removable jaws



**07-9041 - 07-9042**  
WOLFF  
**07-9041** 180 mm  
**07-9042** 240 mm  
plaster breakers



# Amputation Saws



1/3

**06-8008**  
**CHARRIERE**  
 Length of blade  
 215 mm  
 complete with one saw  
 blade each (**06-8009** and **06-8010**)  
 350 mm

Spare saw blades, carbon steel  
**06-8009** 12 mm  
**06-8010** 20 mm

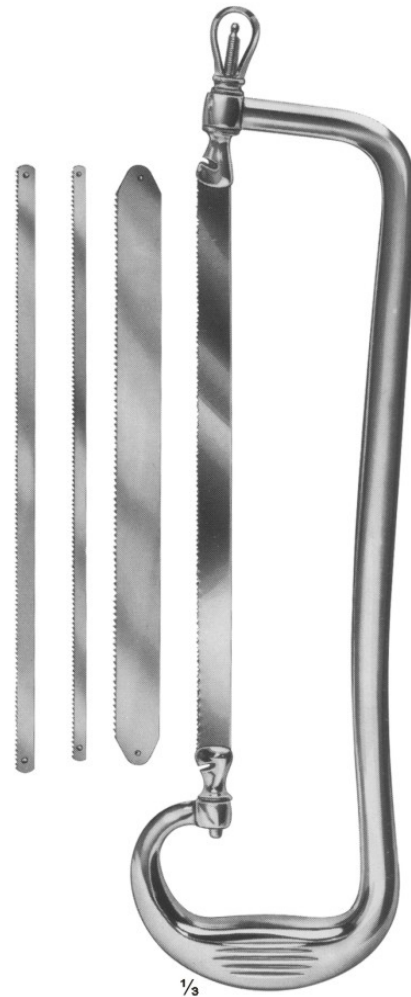

1/3

**06-8011**  
**RUST**  
 Length of blade  
 235 mm  
 complete with one saw  
 blade each (**06-8013**, **06-8014**  
 and 2 saw blades **06-8015**)  
 390 mm  
**06-8012** Bow only

Spare saw blades, carbon steel  
**06-8013** 6 mm  
**06-8014** 8 mm  
**06-8015** 12 mm  
**06-8016** 20 mm

## Amputation Saws

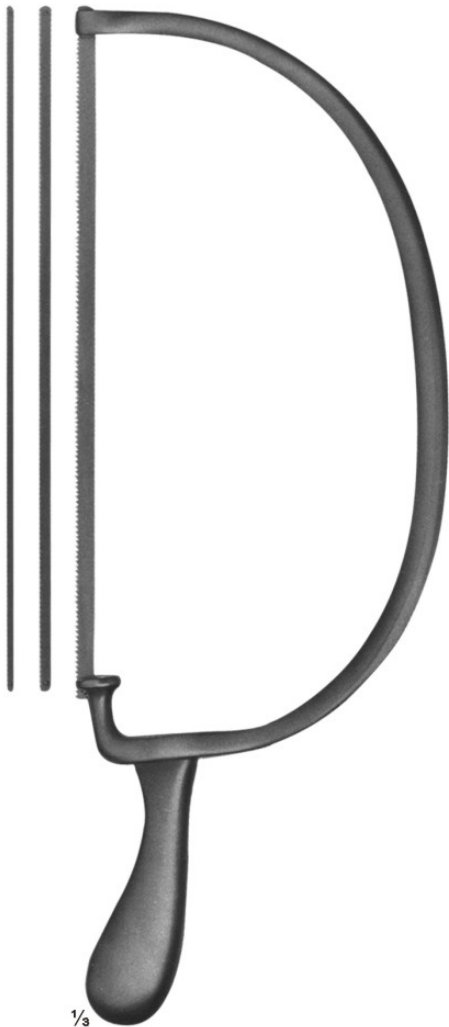

1/3

**06-8017**  
BIER  
Length of blade  
270 mm  
complete with one saw  
blade each (**06-8018**, **06-8019** and **06-8020**)  
420 mm

Spare saw blades, carbon steel

**06-8018** 4 mm  
**06-8019** 6 mm  
**06-8020** 8 mm

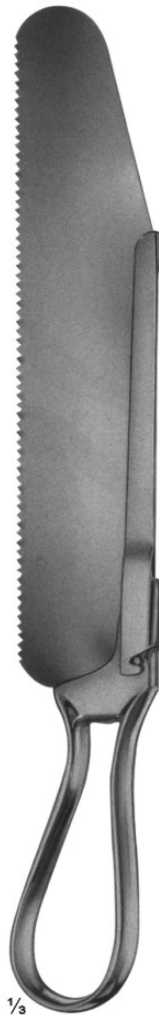

1/3

**06-8021**  
CHARRIERE  
Length of blade  
180 mm  
Spare saw blade,  
carbon steel (**06-8022**)  
270 mm

**06-8023**  
CHARRIERE  
Length of blade  
240 mm  
Spare saw blade,  
carbon steel (**06-8024**)  
340 mm

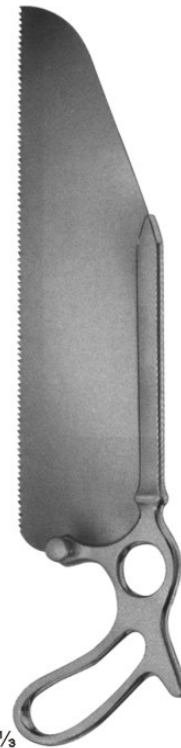

1/3

**06-8025**  
SATTERLEE  
Length of blade  
200 mm  
Spare saw blade,  
carbon steel (**06-8026**)  
200 mm



1/3

**06-8027**  
LANGENBECK  
Length of blade  
115 mm  
Metacarpal saw  
235 mm

## Wire Saws And Conductor

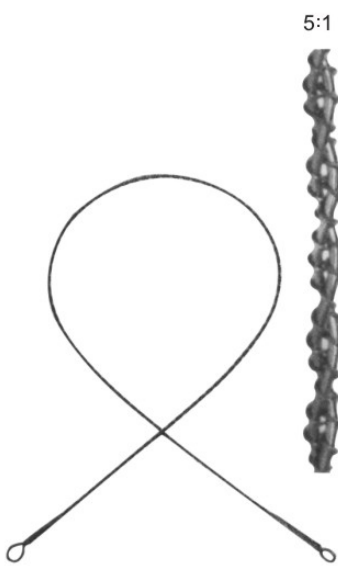

**06-8028 - 06-8031**  
OLIVECRONA  
**06-8028** 300 mm  
**06-8029** 400 mm  
**06-8030** 500 mm  
**06-8031** 700 mm

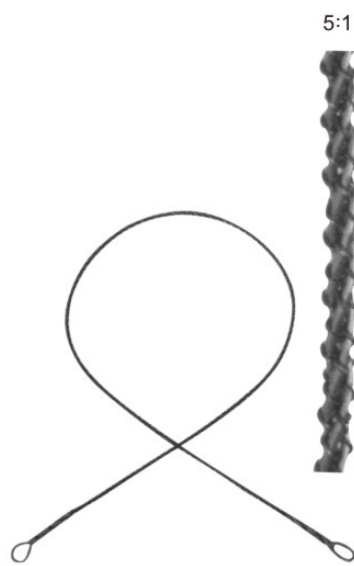

**06-8032 - 06-8035**  
GIGLI  
**06-8032** 300 mm  
**06-8033** 400 mm  
**06-8034** 500 mm  
fine, 6 wires twisted  
**06-8035** 500mm  
coarse, 4 wires twisted



**06-8036**  
GIGLI  
Handle



**06-8037**  
LEBSCH  
Conductor for  
wire saws, malleable  
250 mm

# Elevators and Bone Levers

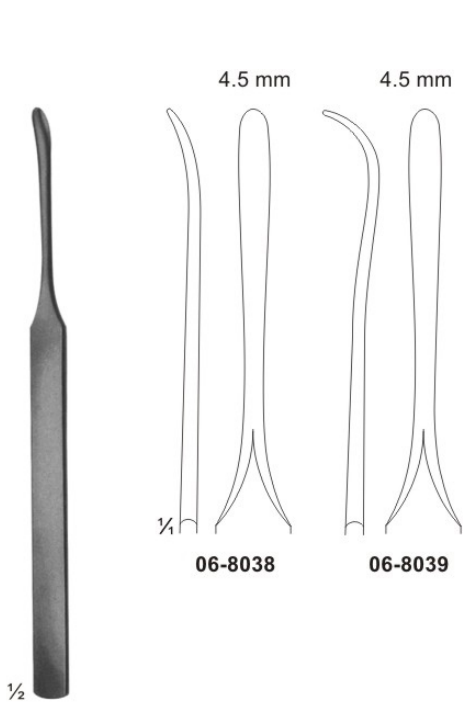

**06-8038 - 06-8039**  
**KOENIG**  
 155 mm

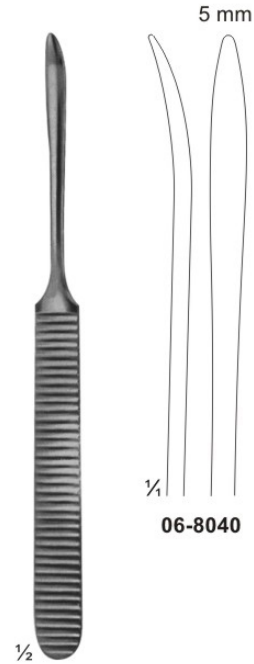

**06-8040**  
**WILLIGER**  
 165 mm

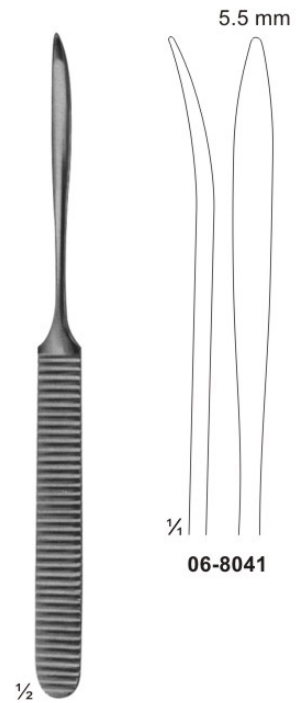

**06-8041**  
**WILLIGER**  
 170 mm

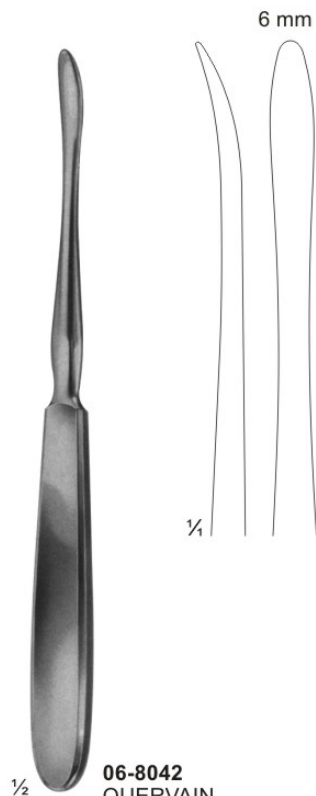

**06-8042**  
**QUERVAIN**  
 195 mm

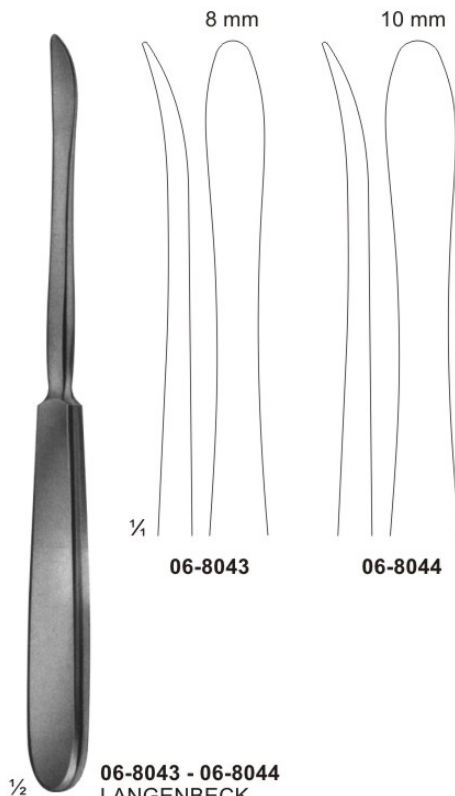

**06-8043 - 06-8044**  
**LANGENBECK**  
 195 mm

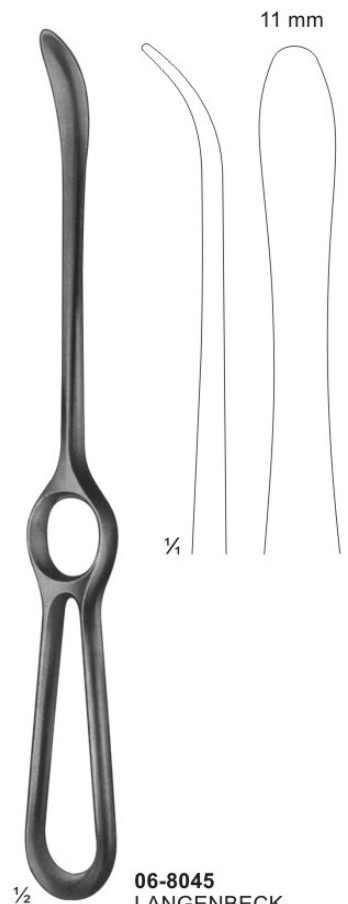

**06-8045**  
**LANGENBECK**  
 230mm



## Bone Levers

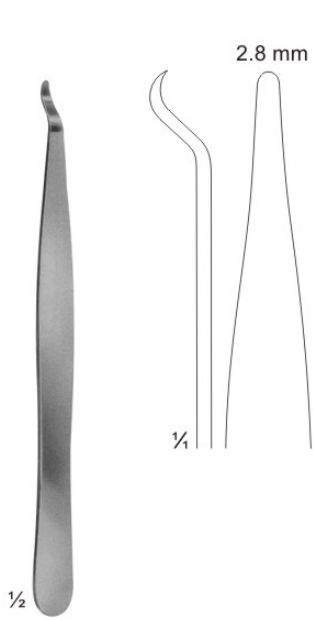

**06-8046**  
140mm

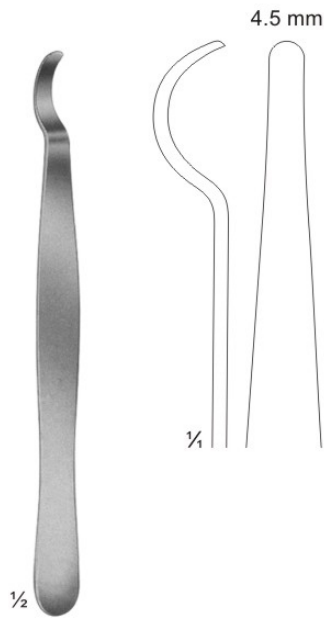

**06-8047**  
150mm

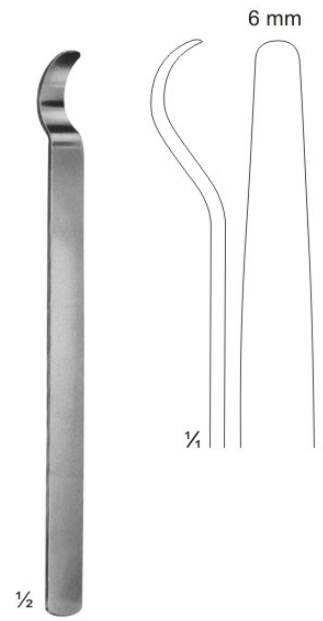

**06-8048**  
150mm

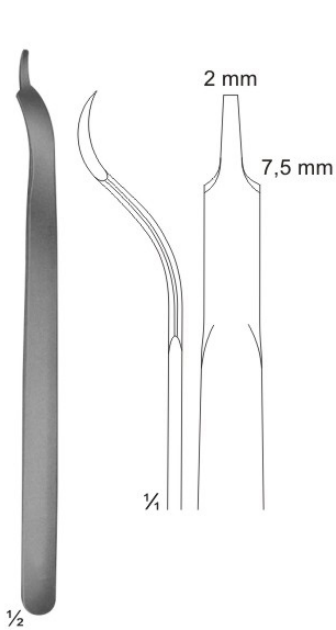

**06-8049**  
BUCK-GRAMCKO  
150mm

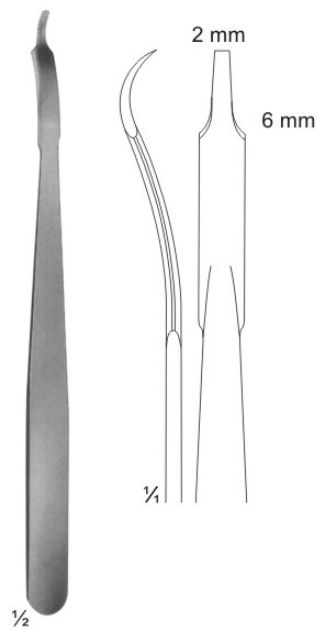

**06-8050**  
160mm

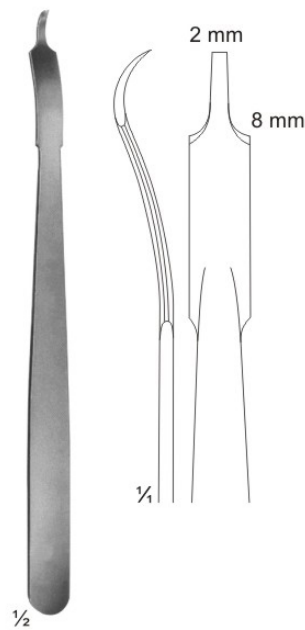

**06-8051**  
160mm

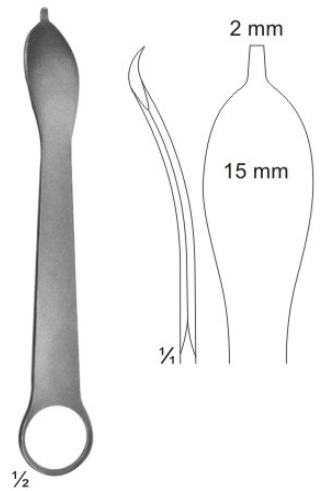

**06-8052**  
125mm

# Bone Levers

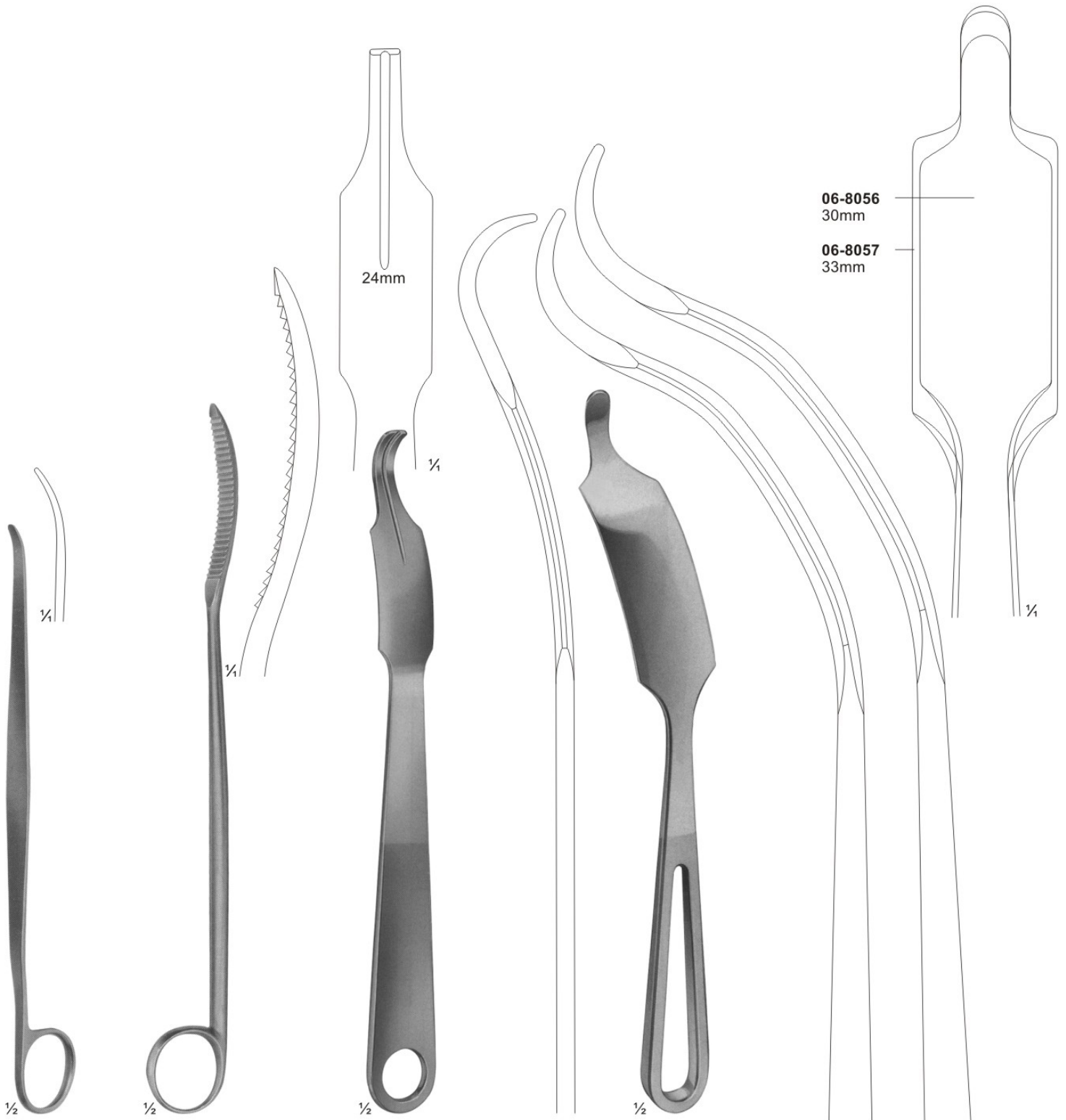

**06-8053**  
LANE TRETHOWAN  
215mm

**06-8054**  
LANE  
255mm

**06-8055**  
LANGE-HOHMANN  
250mm

**06-8056 - 06-8057**  
LANGE-HOHMANN  
modif  
**06-8056** 265mm  
**06-8057** 280mm

## Bone Levers



**06-8058**  
WAGNER  
220 mm

**06-8059**  
220 mm

**06-8060**  
240 mm

**06-8061**  
240 mm

# Bone Levers

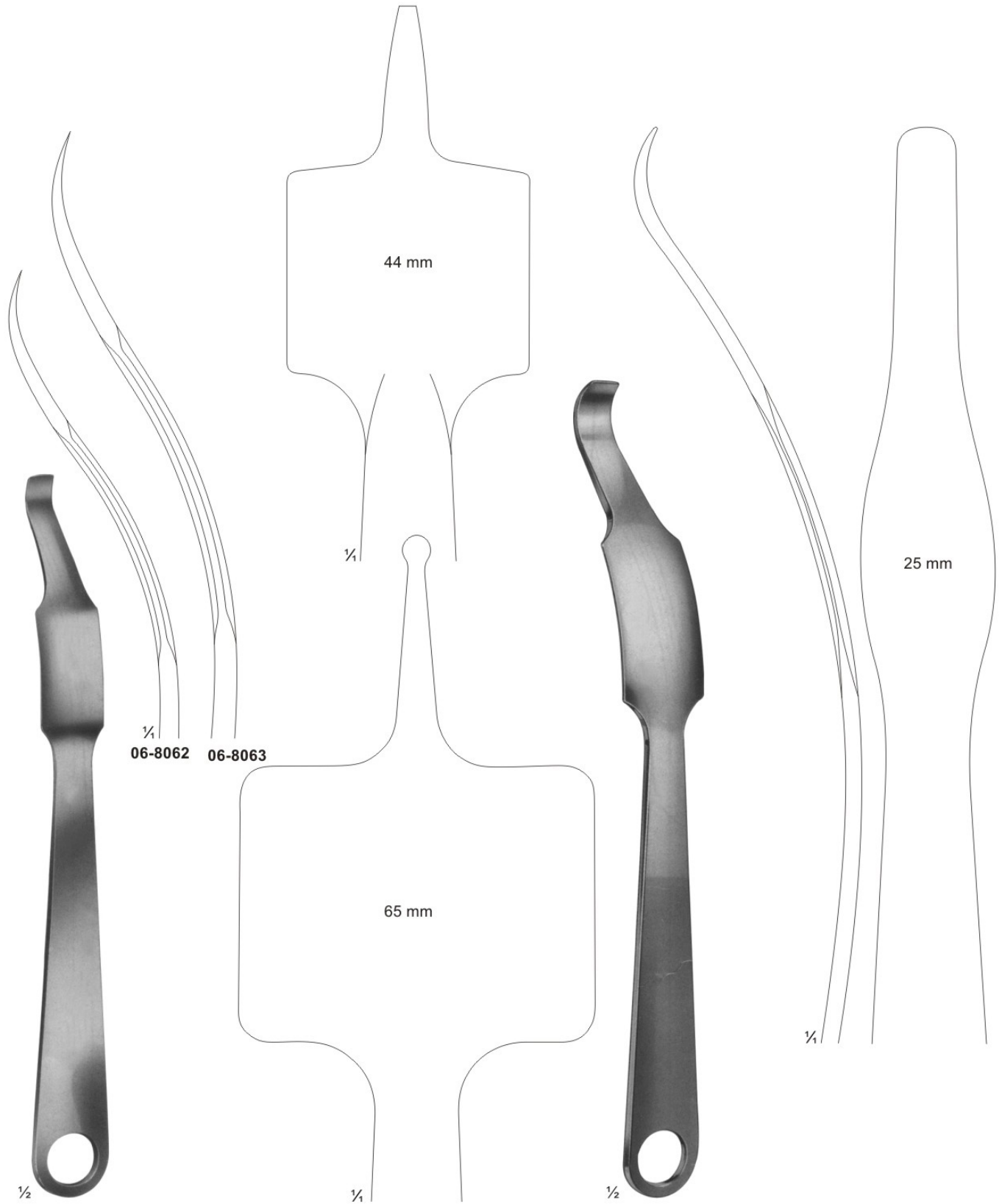

**06-8062 - 06-8063**  
**VERBRUGGE-MULLER**  
**06-8062** 240 mm  
**06-8063** 255 mm

**06-8064**  
 260 mm



# Bone Levers

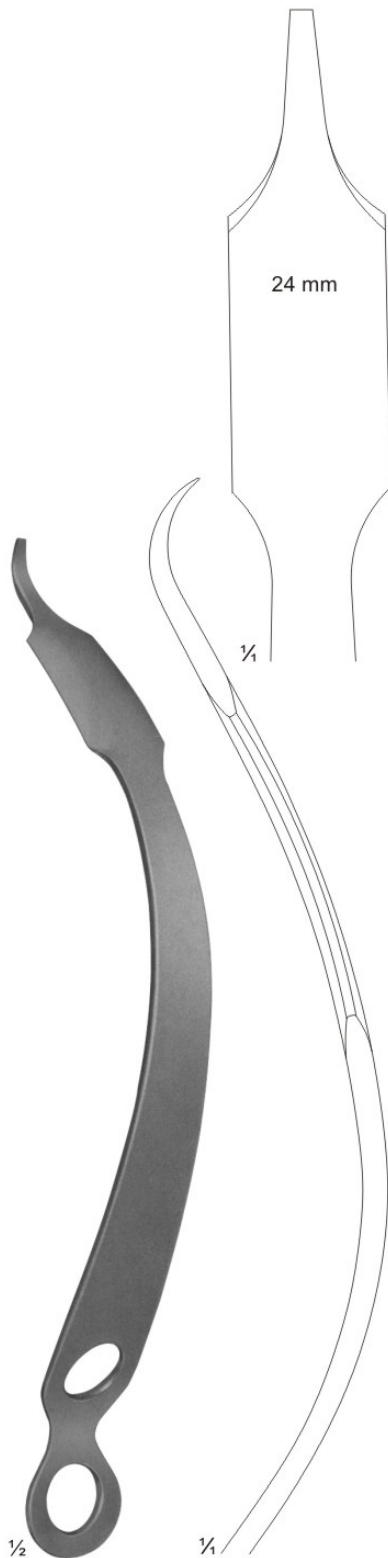

**06-8065**  
HOHMANN-ALDINGER  
270 mm



**06-8066**  
SCHUMACHER mod. WAGNER  
345 mm

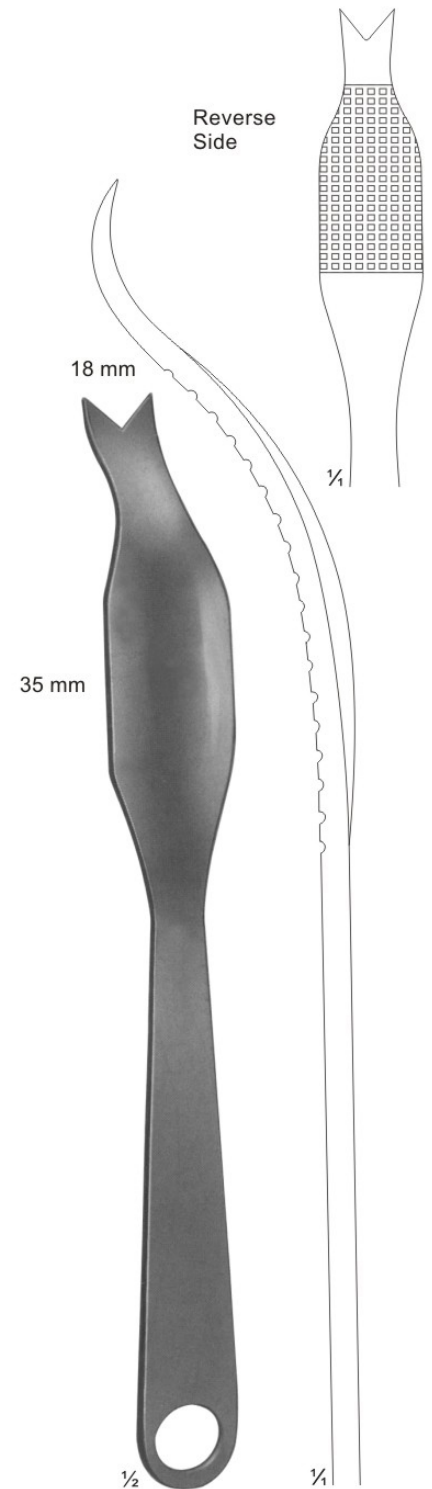

**06-8067**  
SCHUMACHER  
290 mm

## Special Bone Levers

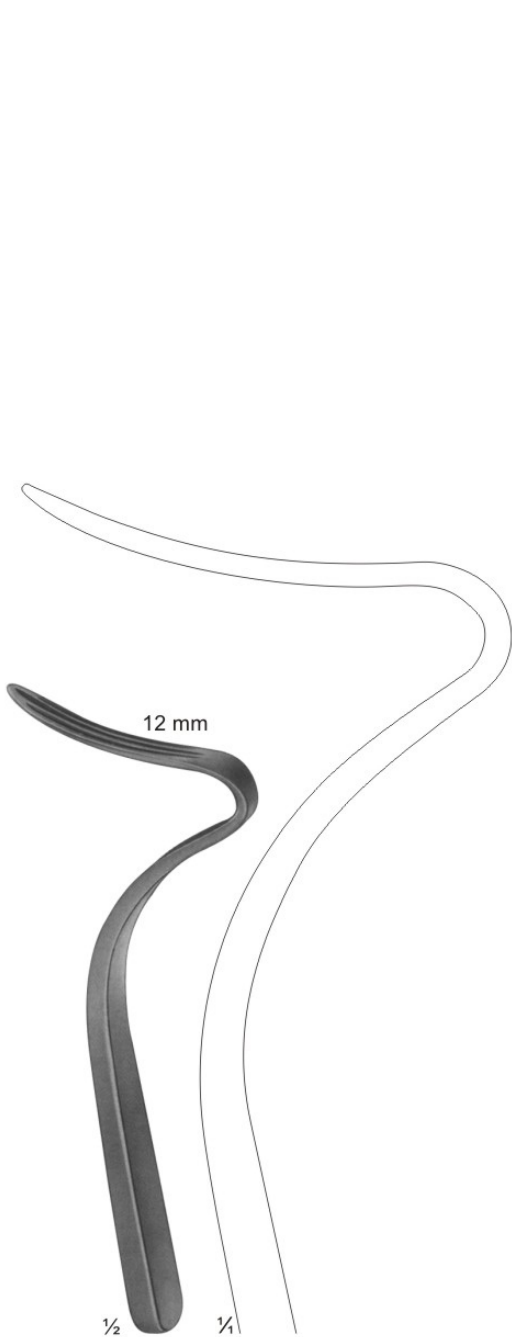

**06-8068**  
**TAGER**  
Bone lever for  
angle joint operations  
175 mm



**06-8069**  
**BENNETT**  
235 mm

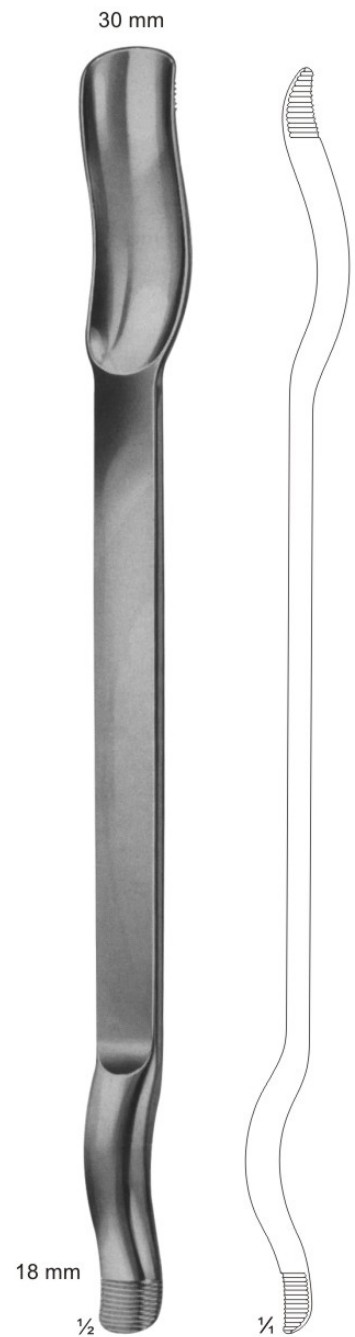

**06-8070**  
**MURPHY-LANE**  
Luxation lever  
340 mm

# Raspatories

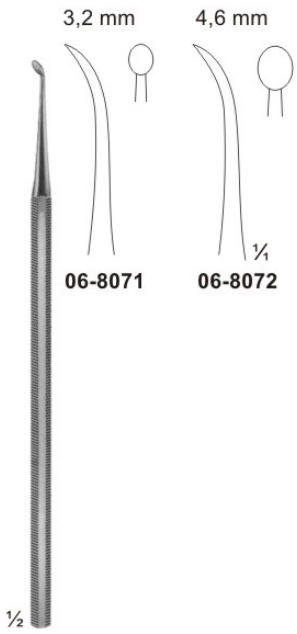

**06-8071 - 06-8072**  
PARTSCH  
150 mm

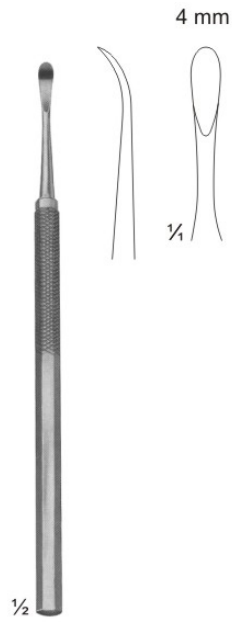

**06-8073**  
PARTSCH mod. LANGE  
145 mm

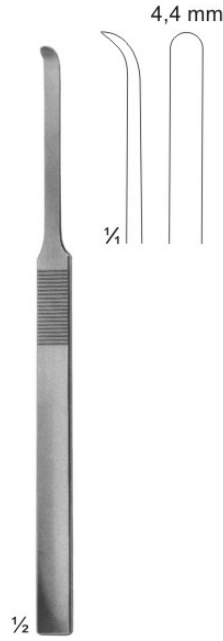

**06-8074**  
MC KENTY  
155 mm

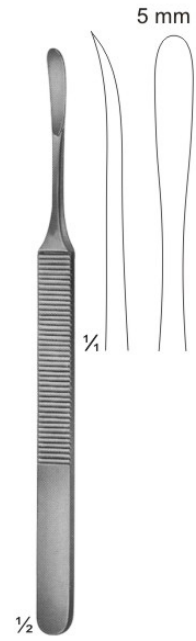

**06-8075**  
KOENIG  
155 mm

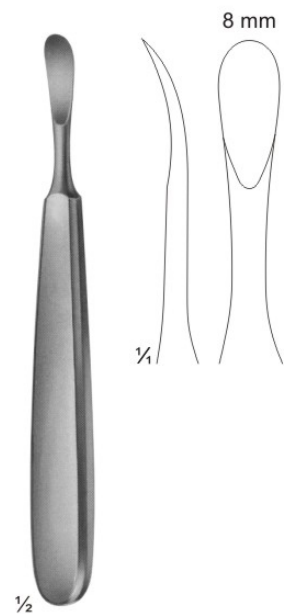

**06-8076**  
TRELAT  
150 mm

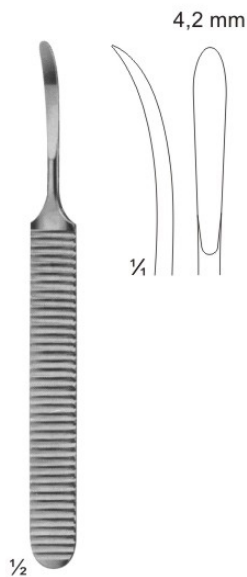

**06-8077**  
WILLIGER  
140 mm

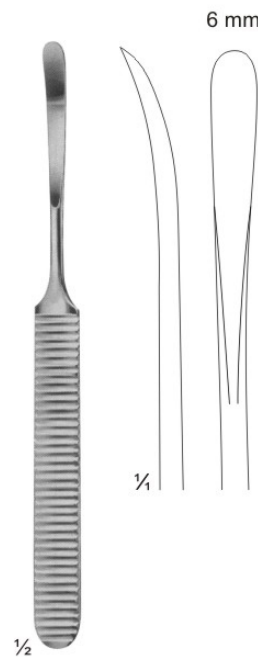

**06-8078**  
WILLIGER  
160 mm

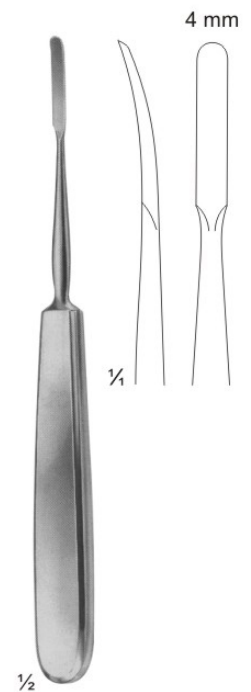

**06-8079**  
JOSEPH  
170 mm

# Raspatories

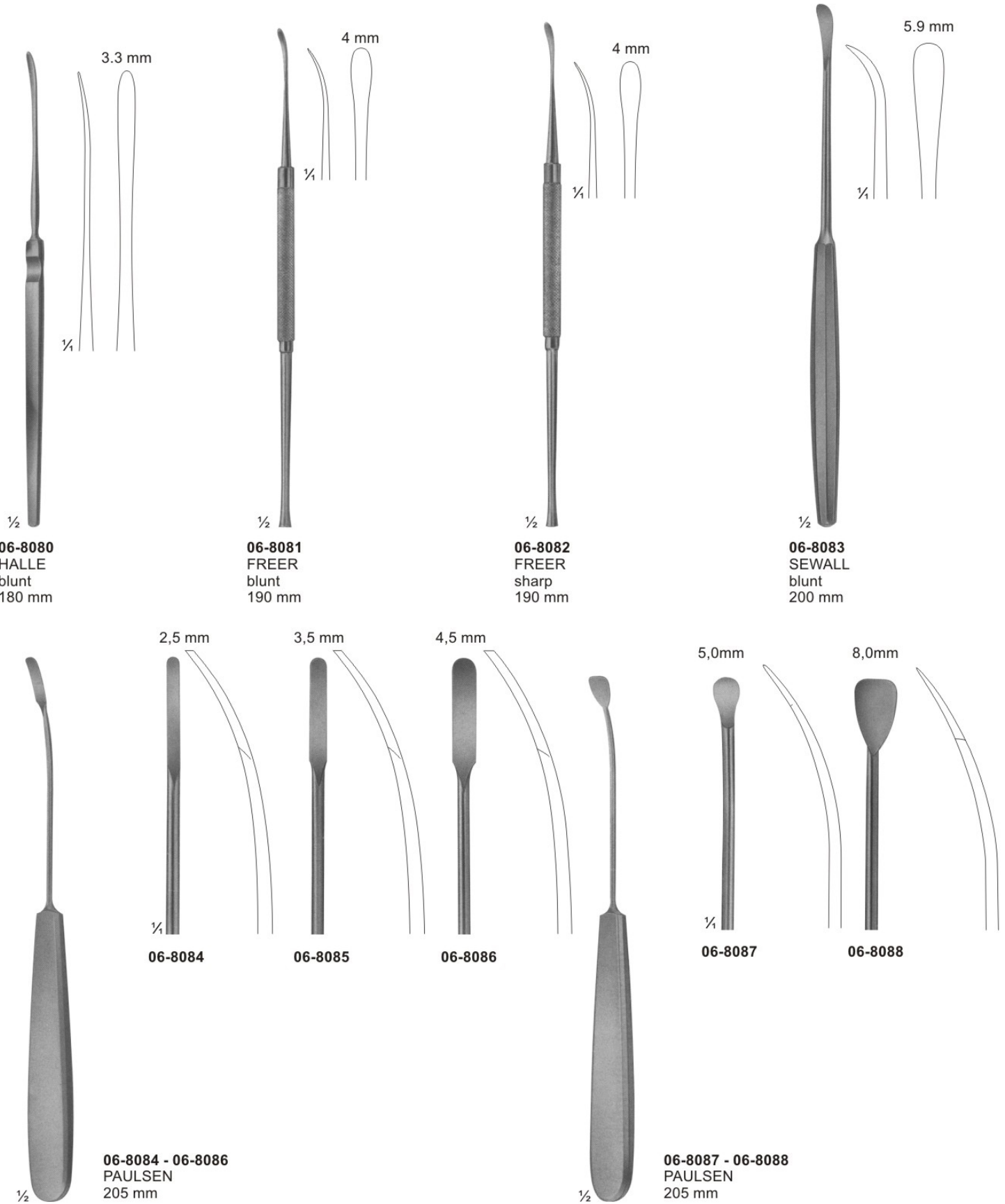

3.3 mm  
¼  
½

**06-8080**  
HALLE  
blunt  
180 mm

4 mm  
¼  
½

**06-8081**  
FREER  
blunt  
190 mm

4 mm  
¼  
½

**06-8082**  
FREER  
sharp  
190 mm

5.9 mm  
¼  
½

**06-8083**  
SEWALL  
blunt  
200 mm

2,5 mm  
¼

**06-8084**

3,5 mm  
¼

**06-8085**

4,5 mm  
¼

**06-8086**

½

**06-8084 - 06-8086**  
PAULSEN  
205 mm

½

5,0mm  
¼

**06-8087**

8,0mm  
¼

**06-8088**

**06-8087 - 06-8088**  
PAULSEN  
205 mm



# Raspatories



**06-8089**  
KILLIAN  
sharp/blunt  
185 mm

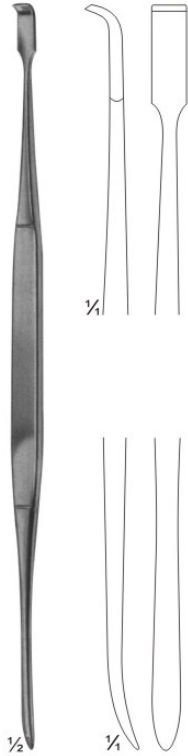

**06-8090**  
HOWARTH  
sharp/blunt  
215 mm

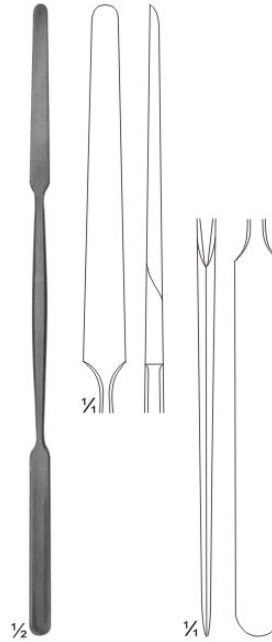

**06-8091**  
KILLIAN  
sharp/blunt  
185 mm

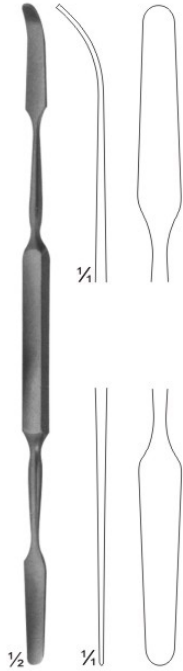

**06-8092**  
MAC DONALD  
blunt/blunt  
185 mm

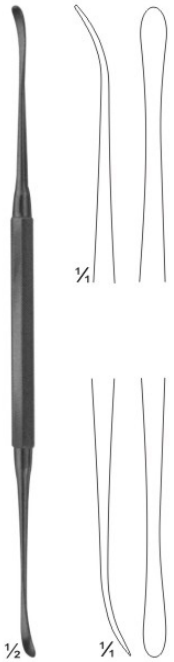

**06-8093**  
FREER  
sharp/blunt  
185 mm

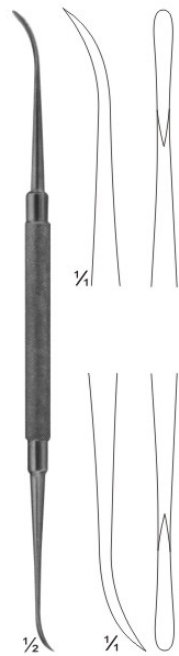

**06-8094**  
FREER-YASARGIL  
sharp/sharp  
185 mm

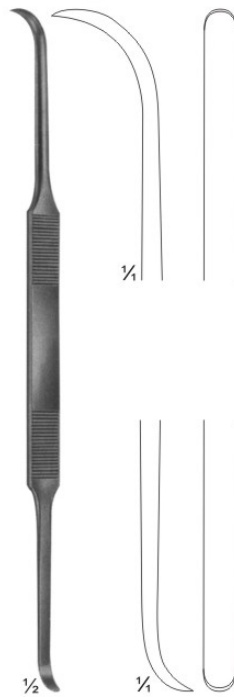

**06-8095**  
COTTLE  
sharp/sharp  
200 mm

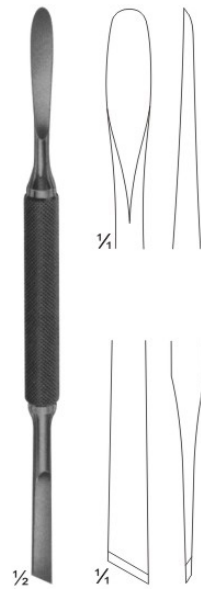

**06-8096**  
MEAD  
sharp/sharp  
165 mm

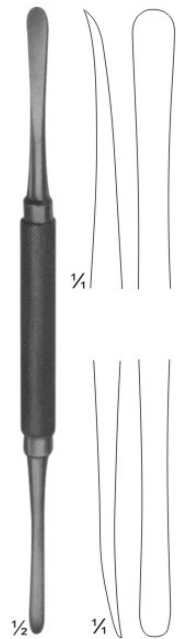

**06-8097**  
MOLT  
sharp/sharp  
180 mm

# Raspatories

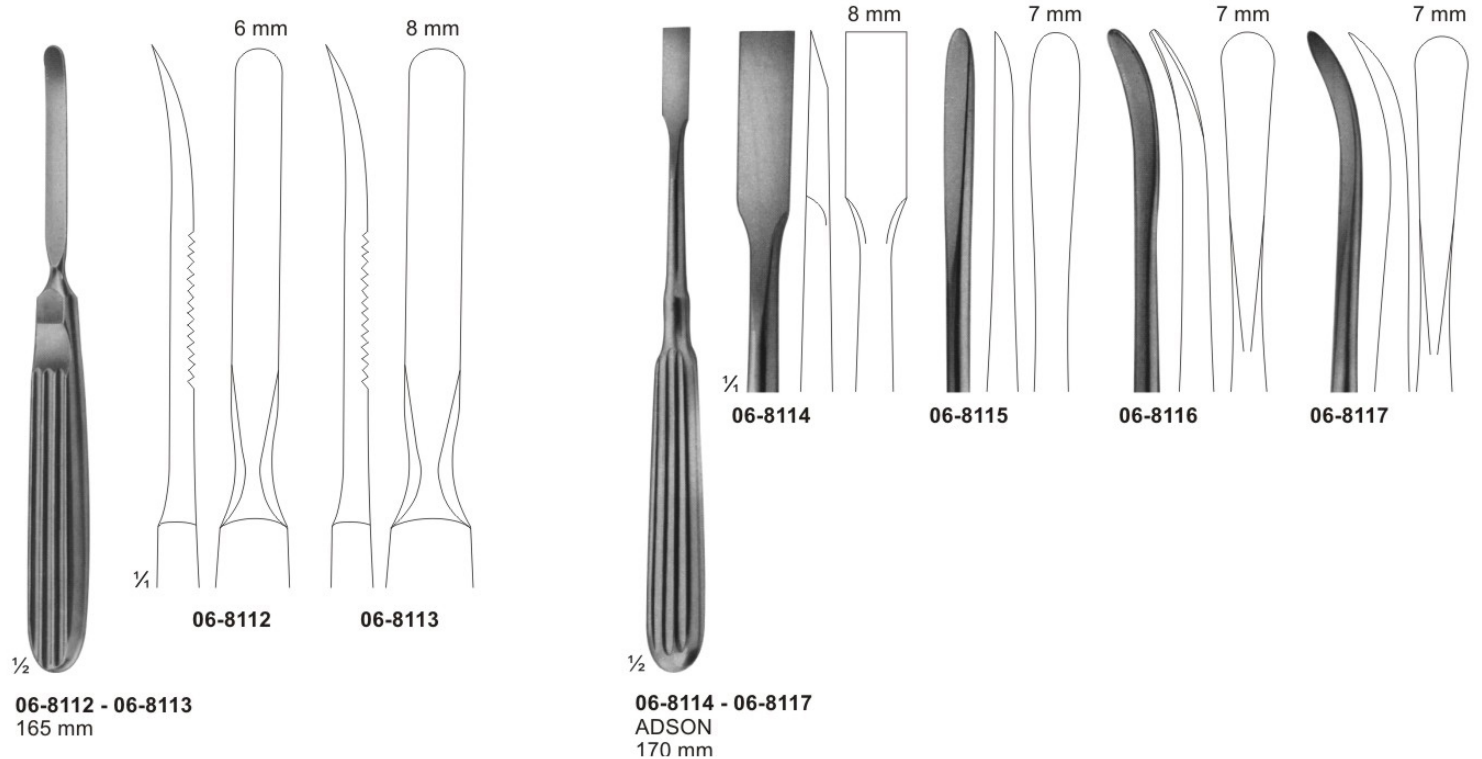
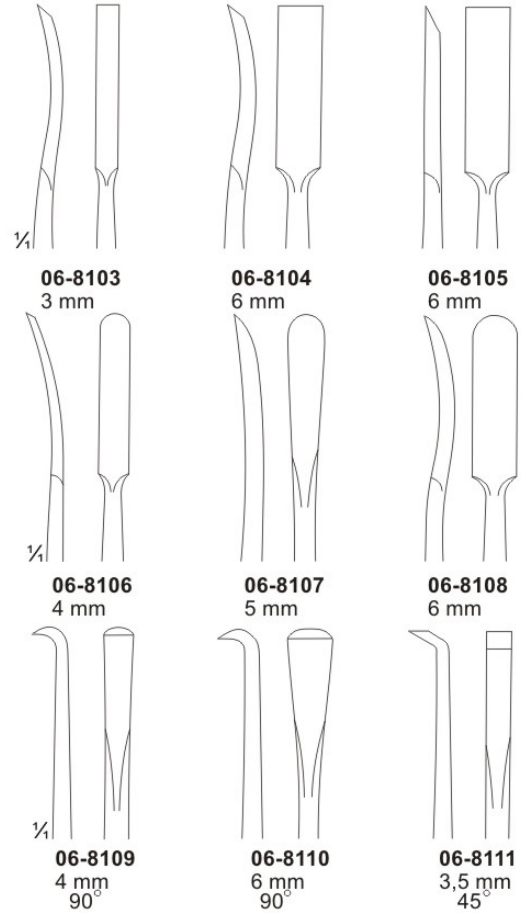
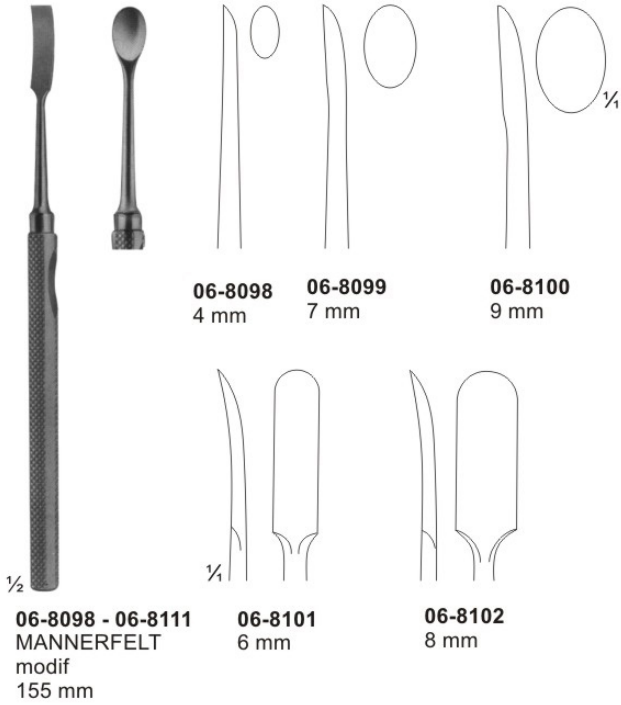

# Raspatories

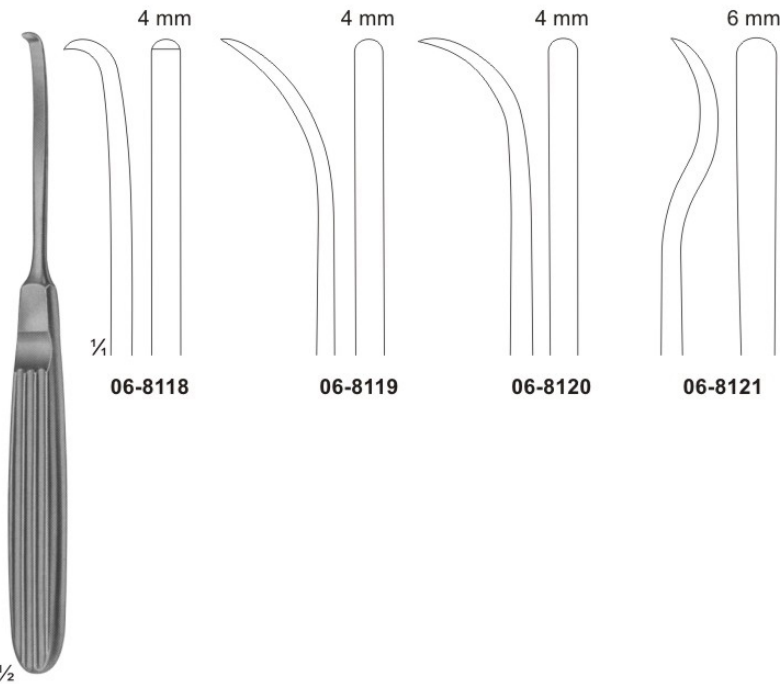

06-8118

06-8119

06-8120

06-8121

06-8118 - 06-8121  
MUEHLING  
170 mm

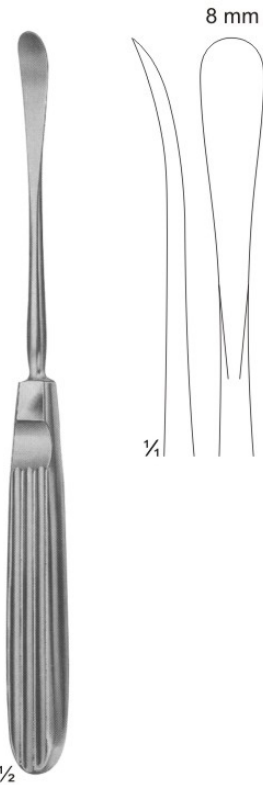

06-8122  
COTTLE  
195 mm

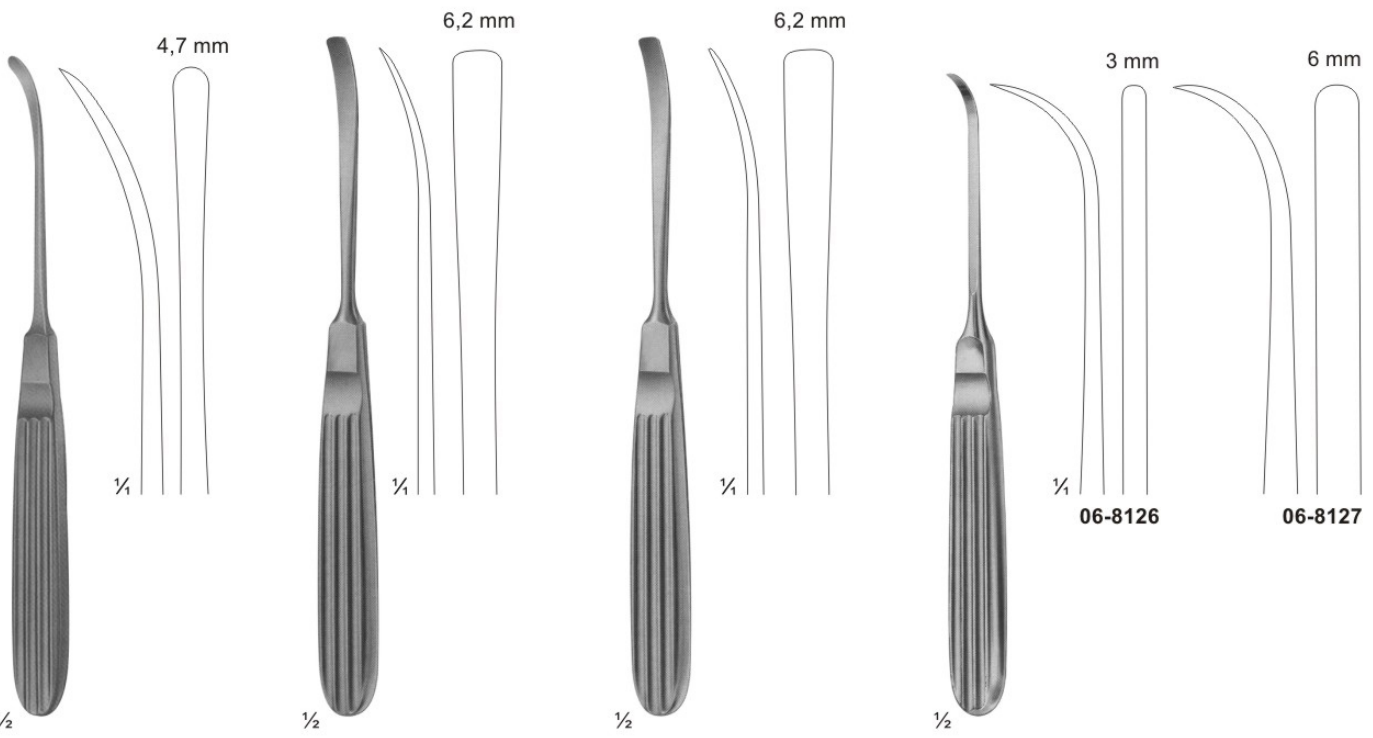

06-8123  
LANDOLT  
175 mm

06-8124  
CASPAR  
180 mm

06-8125  
CASPAR  
180 mm

06-8126 - 06-8127  
170 mm

# Raspatories

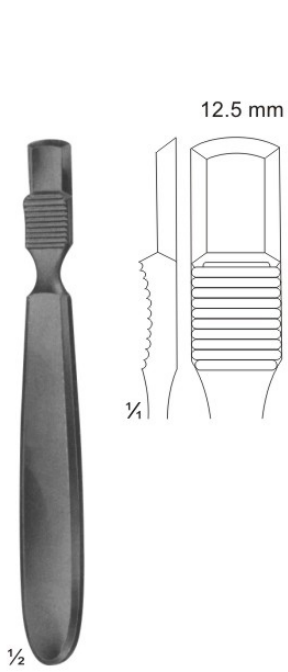

**06-8128**  
FARABEU  
140 mm

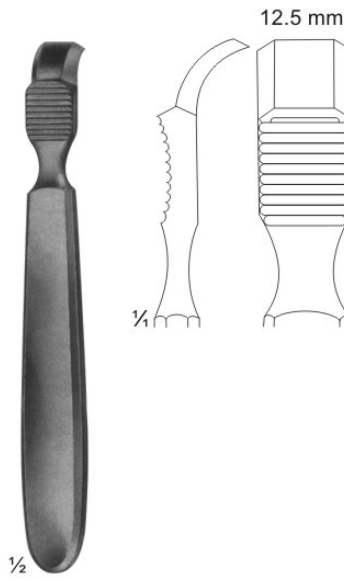

**06-8129**  
FARABEU  
140 mm

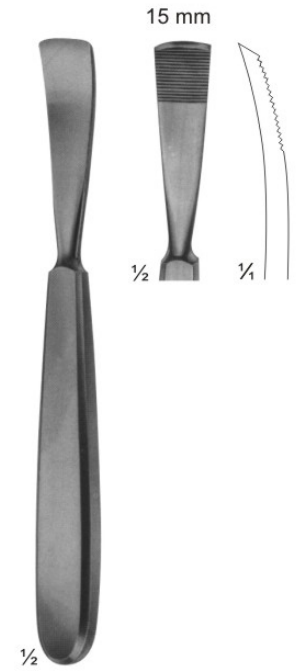

**06-8130**  
JANSEN  
165 mm

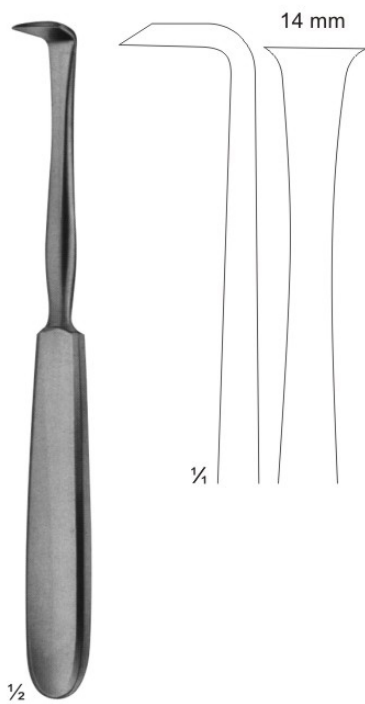

**06-8131**  
LANGENBECK  
180 mm

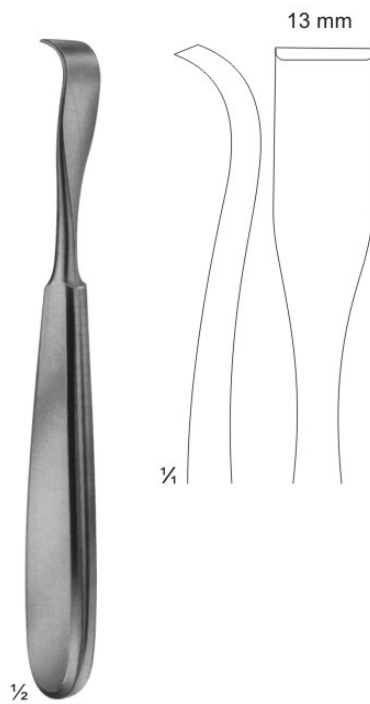

**06-8132**  
SCHNEIDER  
175 mm

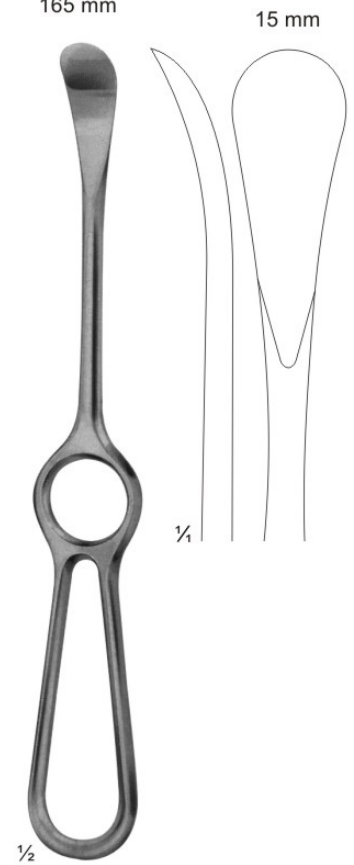

**06-8133**  
SEDILLOT  
215 mm



# Raspatories

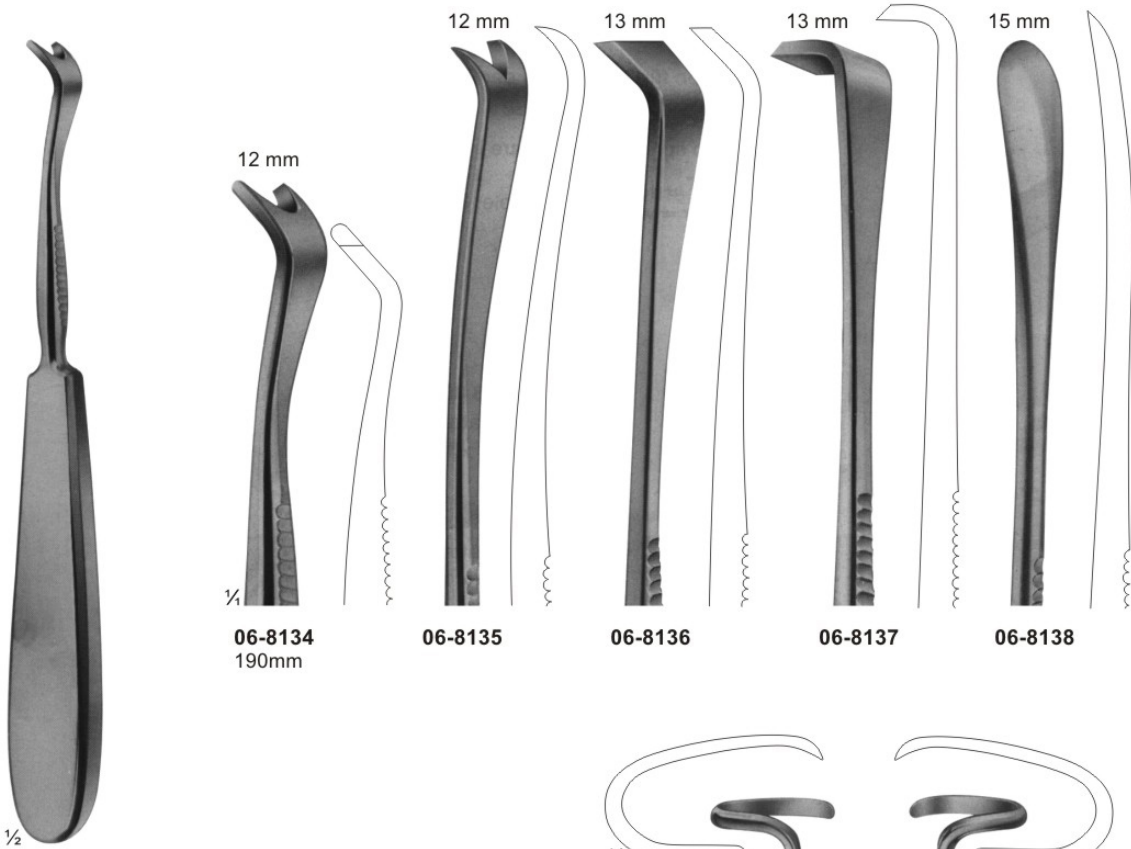

06-8134 - 06-8138  
SEMB  
230 mm



06-8143

06-8144



06-8139 - 06-8140  
DOYEN for children  
06-8141 - 06-8142  
for adults 175 mm

06-8143 - 06-8144  
DOYEN  
240 mm

# Raspatories with HARTPRESS-handle

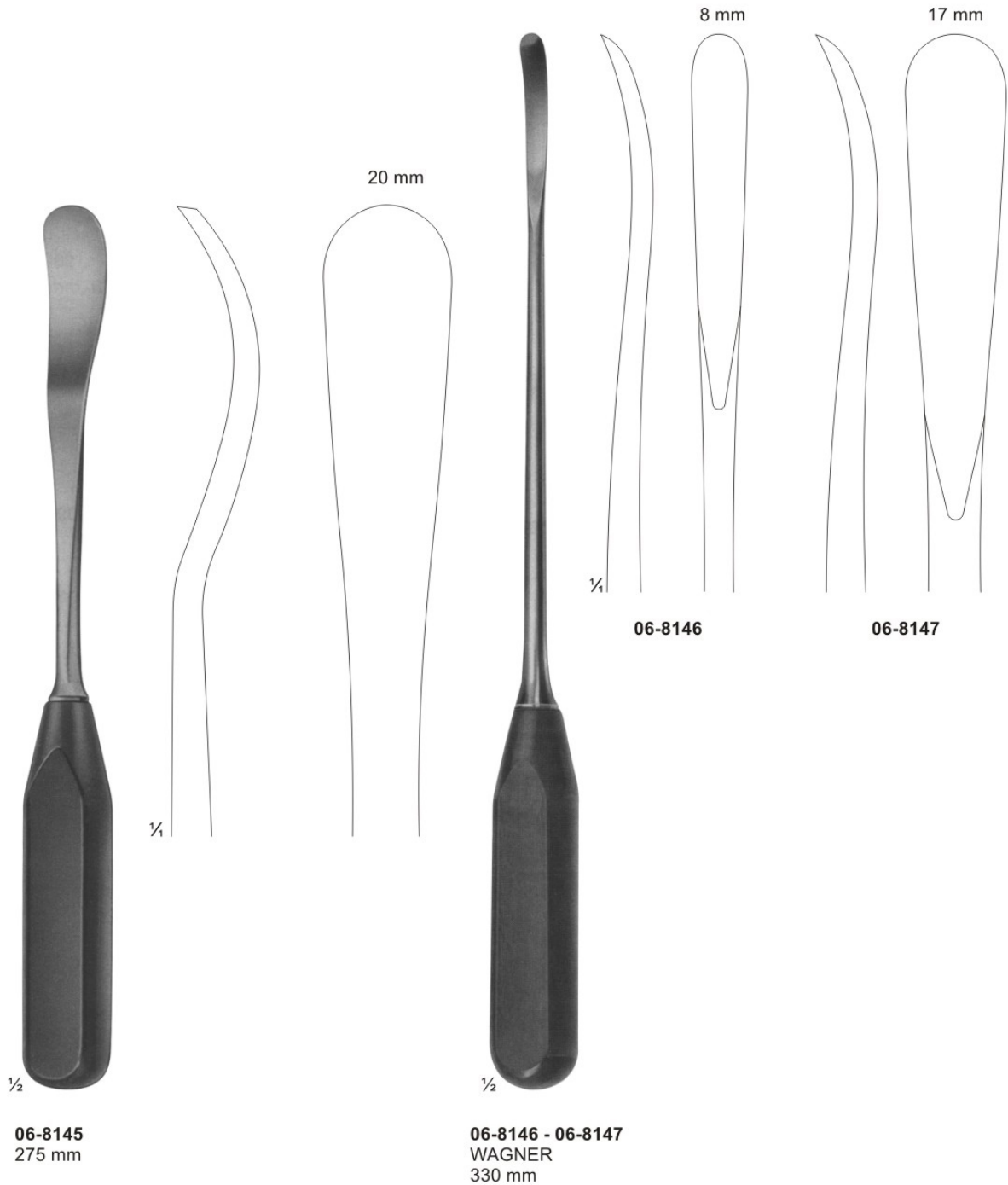

# Bone File and Rasps

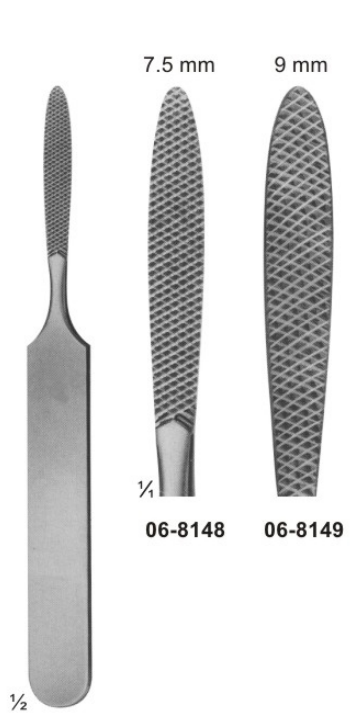

**06-8148**  
JOSEPH  
fine, chequered

**06-8149**  
coarse, chequered  
165 mm



**06-8152**  
MALTZ  
down stroke  
180 mm



**06-8153**  
AUFRICHT  
up stroke  
**06-8154**  
down stroke  
220 mm

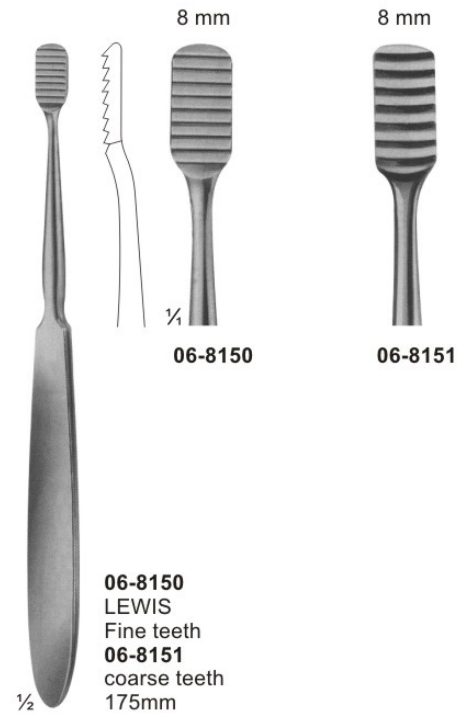

**06-8150**  
LEWIS  
Fine teeth  
**06-8151**  
coarse teeth  
175mm

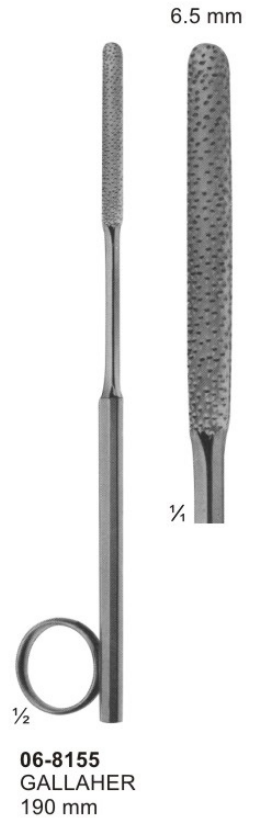

**06-8155**  
GALLAHER  
190 mm



# Bone File and Rasps, Durogrip Rasps

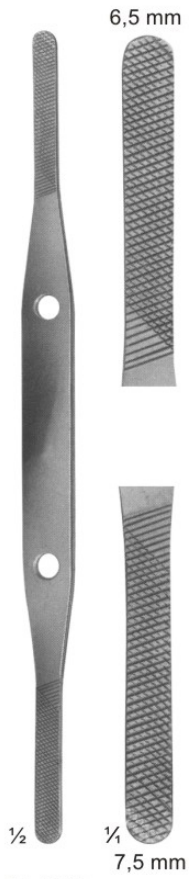

**06-8156**  
FOMON  
215mm

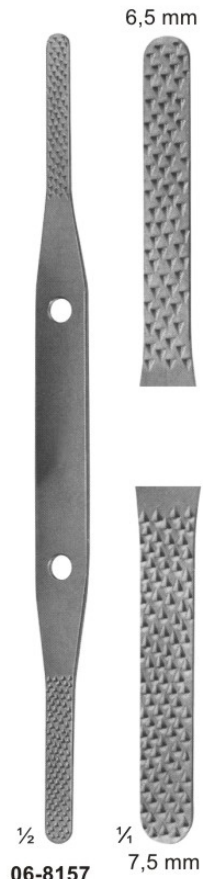

**06-8157**  
FOMON  
215mm

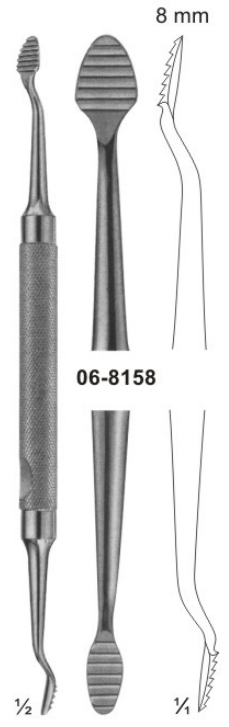

**06-8158 - 06-8160**  
MILLER  
180 mm

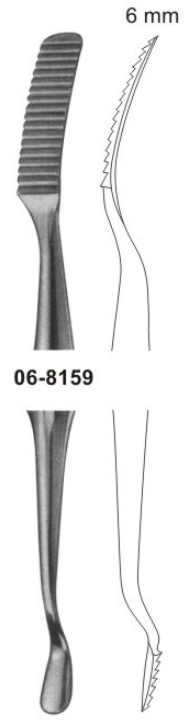

**06-8159**

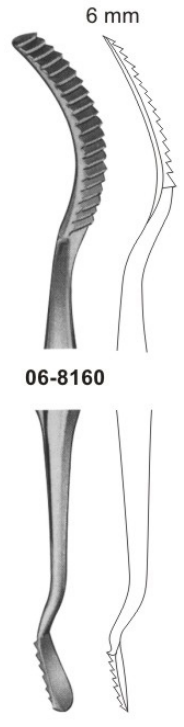

**06-8160**



**06-8161**  
DUROGRIP  
205 mm

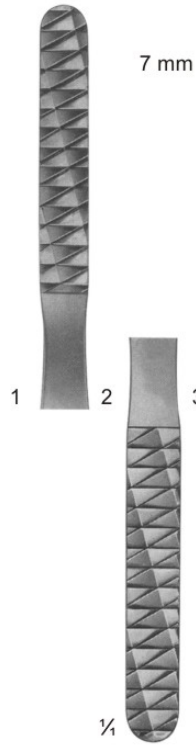

**06-8162**  
Teeth 12/14

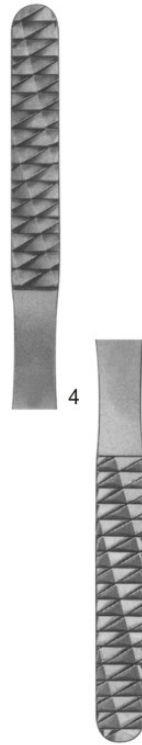

**06-8163**  
16/20

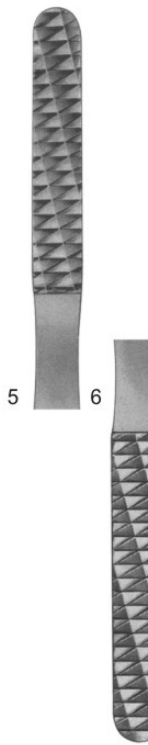

**06-8164**  
24/30

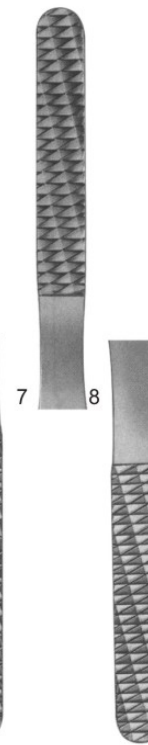

**06-8165**  
36/44

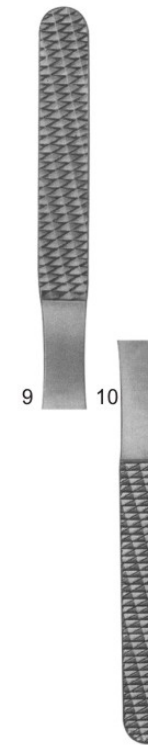

**06-8166**  
52/62



# Bone File and Rasps

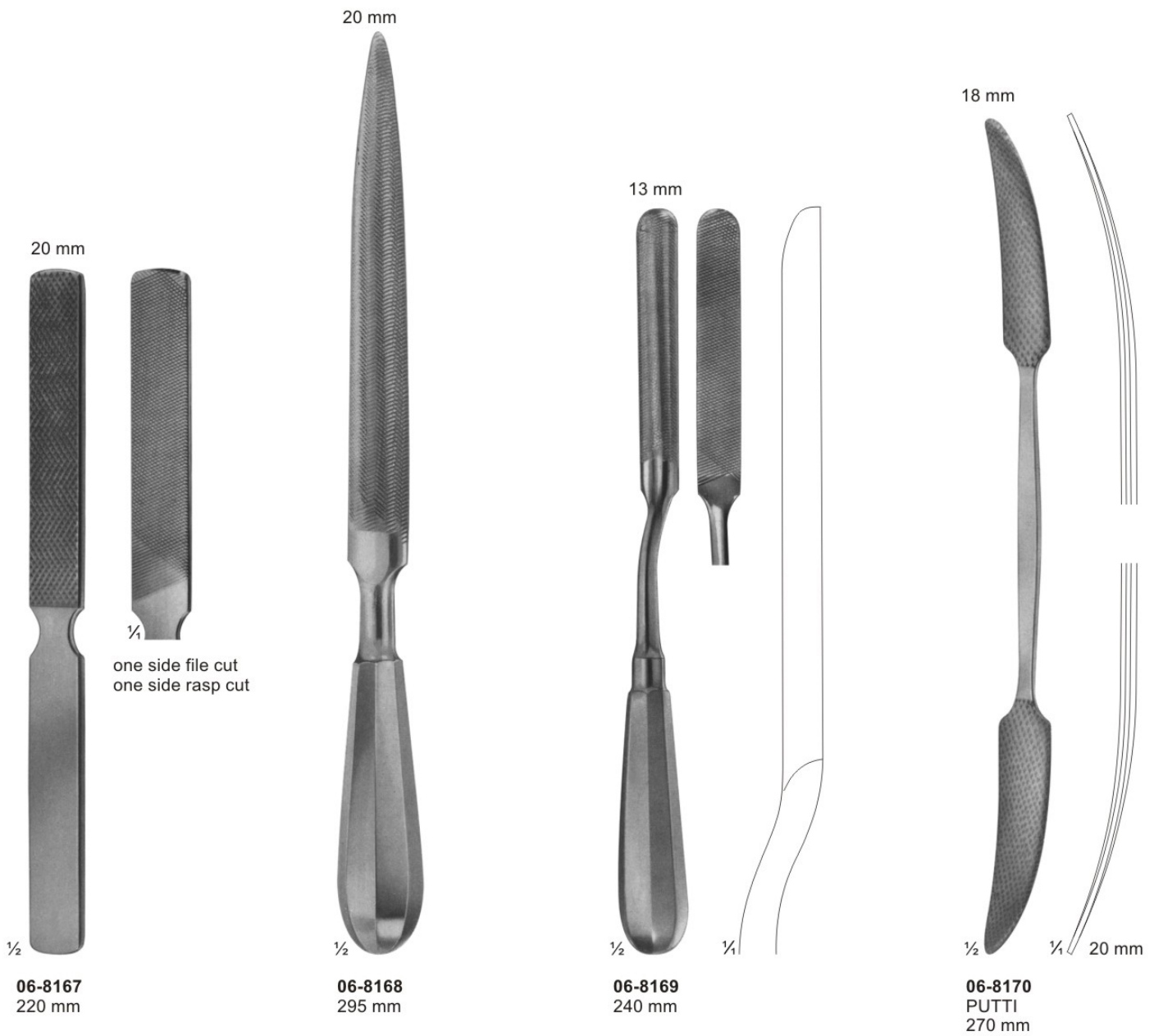

## Bone Curettes



**06-8171**  
JACOBSON  
140 mm

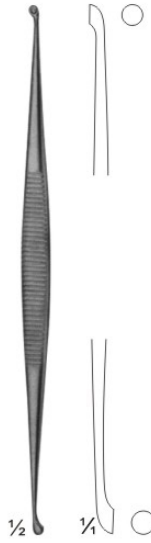

**06-8172**  
MARTINI  
140 mm

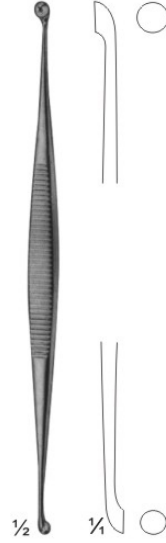

**06-8173**  
MARTINI  
140 mm



**06-8174**  
WILLIGER  
145 mm



**06-8175**  
JANSEN  
160 mm

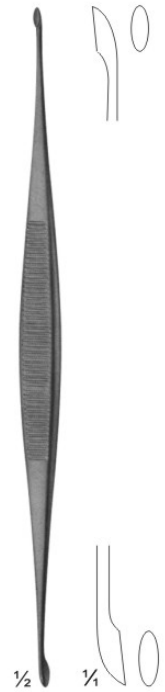

**06-8176**  
BARTH  
180 mm

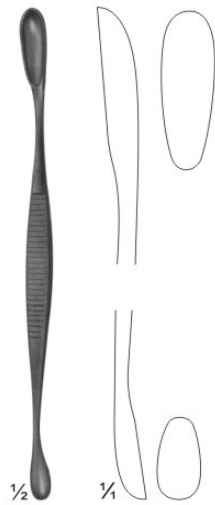

**06-8177**  
VOLKMANN  
130 mm

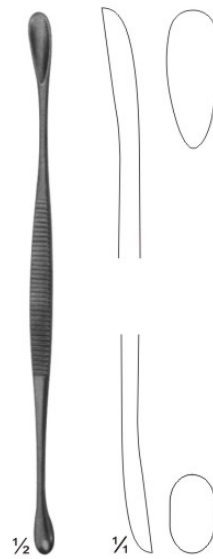

**06-8178**  
VOLKMANN  
145 mm

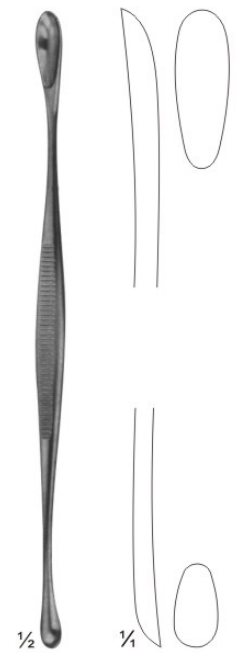

**06-8179**  
VOLKMANN  
170 mm

# Bone Currettes



**06-8180**  
JANSEN  
160 mm



**06-8181**  
HEMINGWAY  
170 mm

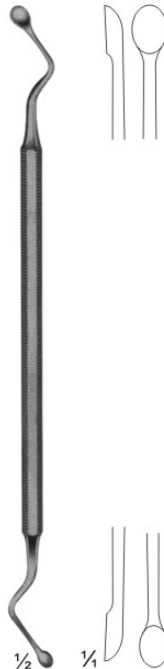

**06-8182**  
HEMINGWAY  
175 mm

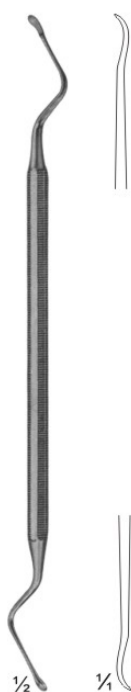

**06-8183**  
LUCAS  
180 mm

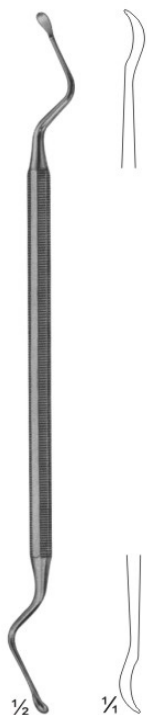

**06-8184**  
LUCAS  
185 mm



**06-8185 - 06-8187**  
KERPEL  
145 mm



**06-8186 - 06-8188**  
KERPEL  
145 mm

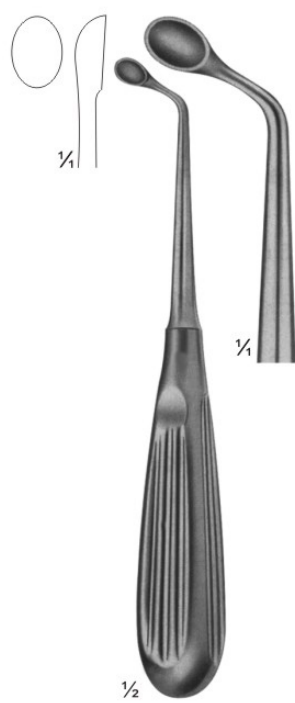

**06-8189**  
UFFENDORDE  
170 mm



**06-8190**  
UFFENDORDE  
170 mm

# Bone Currettes

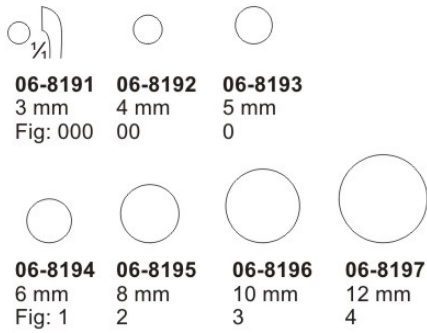

½

**06-8191 - 06-8197**  
BRUNS  
165 mm

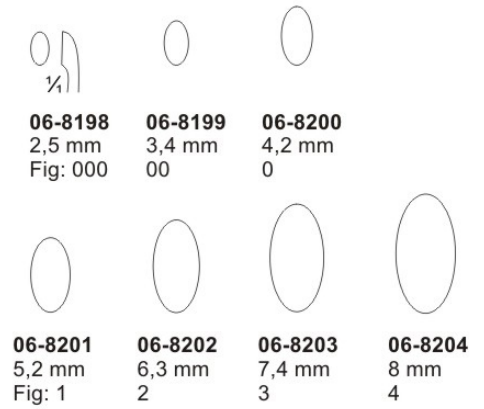

½

**06-8198 - 06-8204**  
SCHEDE  
170 mm

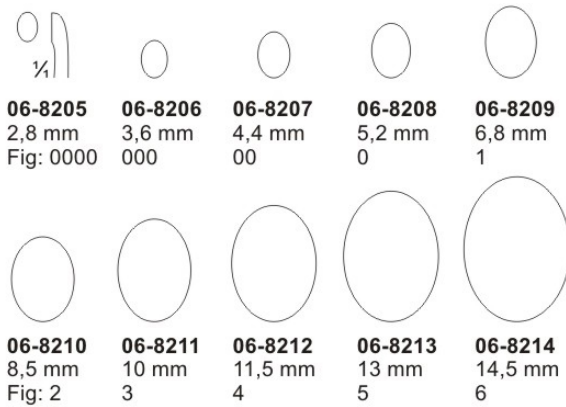

½

**06-8205 - 06-8214**  
VOLKMANN  
170 mm

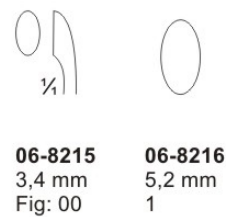

½

**06-8215 - 06-8216**  
WILLIGER  
170 mm



# Bone Curettes



**06-8217**  
1,8 mm

**06-8218**  
2,0 mm

**06-8219**  
2,4 mm

**06-8220**  
2,6 mm

**06-8221**  
2,8 mm

1/2

**06-8217 - 06-8221**  
LEMPERT  
215 mm



malleable

**06-8222**  
4,4 mm  
Fig: 00

**06-8223**  
5,2 mm  
Fig: 0

**06-8224**  
6,8 mm  
Fig: 1

1/2

**06-8222 - 06-8224**  
HALLE  
215 mm



**06-8225**  
2,8 mm  
Fig: 0000

**06-8226**  
3,6 mm  
Fig: 000

**06-8227**  
4,4 mm  
Fig: 00

**06-8228**  
5,2 mm  
Fig: 0

1/2

**06-8225 - 06-8228**  
DAUBENSPECK  
200 mm



**06-8229**  
3,6 mm  
Fig: 000

**06-8230**  
4,4 mm  
Fig: 00

**06-8231**  
5,2 mm  
Fig: 0

**06-8232**  
6,8 mm  
Fig: 1

1/2

**06-8229 - 06-8232**  
250 mm



**06-8233**  
3,6 mm  
Fig: 000

**06-8234**  
4,4 mm  
Fig: 00

**06-8235**  
5,2 mm  
Fig: 0

**06-8236**  
6,8 mm  
Fig: 1

1/2

**06-8233 - 06-8236**  
250 mm



**06-8237**  
3 mm

**06-8238**  
4 mm

**06-8239**  
5 mm

1/2

**06-8237 - 06-8239**  
BUSHE 250 mm

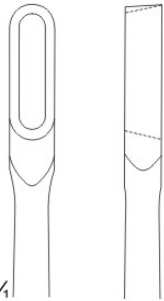

# Bone Curettes

6 mm





06-8240  
TESSIER  
220 mm

1/2

06-8241  
3,6 mm  
Fig: 000





06-8242  
4,4 mm  
Fig: 00



06-8243  
5,2 mm  
Fig: 0

06-8241 - 06-8243  
SIMON  
235 mm

1/2

06-8244  
6,8 mm  
Fig: 1



06-8245  
8,5 mm  
Fig: 2



06-8246  
10 mm  
Fig: 3

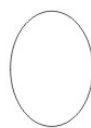

06-8247  
11,5 mm  
Fig: 4





06-8248  
13 mm  
Fig: 5



06-8249  
14,5 mm  
Fig: 6

06-8244 - 06-8249  
SIMON  
240 mm

1/2

06-8250  
3,6 mm  
Fig: 000



06-8251  
4,4 mm  
Fig: 00



06-8252  
5,2 mm  
Fig: 0

06-8250 - 06-8252  
CASPAR  
220 mm

1/2



06-8253  
3,6 mm  
Fig: 000





06-8254  
4,4 mm  
Fig: 00



06-8255  
5,2 mm  
Fig: 0

06-8253 - 06-8255  
CASPAR  
220 mm

1/2

06-8256  
4 mm



06-8257  
5 mm

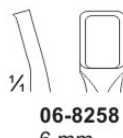

06-8258  
6 mm

06-8256 - 06-8258  
CASPAR  
toothed  
220 mm

1/2



---

**P.O Kharota Propi 51310 silakot Pakistan**  
**Telephone / Fax: +92 052 4360529**  
**Cell # +92 333 8619171**  
**Whatsapp Contact: 0093-33917686 (ITALY)**